



Prosperity Dielectrics Co., Ltd.

No.566-1, Kaoshi Rd., Yangmei, Taoyuan 32668, Taiwan (R.O.C.)

Tel : 886-3-4753355

Fax : 886-3-4854959

Messrs. : _____

Date : 2020/02/25

APPROVAL SHEET

Product Name : Anti-Sulfur General Purpose 5 Layer Ceramic Chip
Capacitors

Part No. : FP Series

Description : Anti-Sulfur Size 0402~2225, C0G/XR, 25V~4000V



PREPARED BY	APPROVED BY

PROSPERITY DIELECTRICS CO., LTD.

_____ 566-1 <http://www.pdc.com.tw>

Tel : 03-4753355 ext :

Fax : 03-4854959

Contactor : _____ Mobile : _____

Prosperity Dielectrics Co., Ltd.

No.566-1, Kaoshi Rd., Yangmei, Taoyuan 32668, Taiwan (R.O.C.)

Tel : 886-3-4753355

Fax : 886-3-4854959

SPECIFICATION

FOR

Product Name : Anti-Sulfur General Purpose 2 Layer Ceramic Chip
Capacitors

Part No. : FP Series

Description : Anti-Sulfur Standard Size 0402~2225, C0G/XR, 25V~4000V



Doc. No. : FP-000-001-16

Rev : 2020/02/25

DRAWN BY	CHECEKED BY	APPROVED BY
Jane Hsiao	Yvens Chou	Joseph Ling

1. INTRODUCTION

POSPERITY Multilayer Ceramic Chip Capacitors supplied in bulk or tape & reel package are ideally suitable for thick-film hybrid circuits and automatic surface mounting on any printed circuit boards.

FP series use a special material between nickel-barrier and ceramic body. It provides excellent performance to against bending stress occurred during process and provide more security for PCB process.

The nickel-barrier terminations are consisted of a nickel barrier layer over the silver metallization and then finished by electroplated solder layer to ensure the terminations have good solderability. The nickel barrier layer in terminations prevents the dissolution of termination when extended immersion in molten solder at elevated solder temperature.

2. FEATURES

- High performance to withstanding 3~5mm of substrate bending test guarantee.
- A wide selection of sizes is available.
- High capacitance in given case size.
- Capacitor with lead-free termination (pure Tin).
- Reduction in PCB bend failure.
- High reliability and stability.
- RoHS & HALOGEN FREE

3. APPLICATIONS

- For general digital circuit.
- For power supply bypass capacitors.
- For consumer electronics.
- For telecommunication.
- DC to DC converter.

4. HOW TO ORDER

FP	32	X	225	K	101	E	G	G
PDC Family	Size	Dielectric	Capacitance	Tolerance	Rated Voltage	Packaging	Thickness	Control Code
Table 1	Table 2	Table 3	Table 4	Table 5	Table 6	Table 7	Table 8	Table 9

Table 1		PDC Family	
Code	Description	Code	Description
FP	Anti-Bend General Purpose Product		

Table 6		Rated Voltage			
Code	Description	Code	Description	Code	Description
6R3	6.3Vdc	101	200Vdc	152	1500Vdc
100	10Vdc	151	250Vdc	202	2000Vdc
160	16Vdc	201	400Vdc	302	3000Vdc
250	25Vdc	301	500Vdc	402	4000Vdc
500	50Vdc	401	630Vdc	502	5000Vdc
101	100Vdc	102	1000Vdc	602	6000Vdc

Table 2		General Purpose			
Code	Description	Code	Description	Code	Description
15	0402 (1005)	32	1210 (1206)	5728	5728
18	0603 (1608)	42	1808 (4526)	55	2220 (5750)
21	0805 (2012)	43	1812 (4532)	56	2225 (5763)
31	1206 (3216)	46	1825 (4563)		

Table 3		Dielectric Material Characteristics	
Code	Description	Code	Description
N	C0G	X	X7R
B	X5R	F	Y5V

Table 7		Packaging Type	
Code	Description	Code	Description
B	Bulk	T	Tray package
E	Tape and 7" Reel, Embossed Tape	P	Tape and 7" Reel, Paper Tape
K	Tape and 10" Reel, Embossed Tape	D	Tape and 10" Reel, Paper Tape
L	Tape and 13" Reel, Embossed Tape	G	Tape and 13" Reel, Paper Tape

Table 4		Capacitance Rule Code	
Code	Description	Code	Description
R47	0.47pF	102	102=10x10 ² =1000pF
0R5	0.5pF	104	104=10x10 ⁴ =100nF
100	100=10x10 ⁰ =10pF	106	106=10x10 ⁶ =10μF

Table 8		Thickness Description			
Code	Description	Code	Description	Code	Description
A	0.60 ± 0.10 mm	I	1.25 ± 0.20 mm	Q	0.50 +0.02/-0.05 mm
B	0.8 + 0.15/-0.10 mm	J	1.15 ± 0.15 mm	R	3.10 ± 0.30 mm
C	1.25 ± 0.10 mm	K	0.50 ± 0.20 mm	S	0.80 ± 0.07 mm
D	1.40 ± 0.15 mm	L	0.30 ± 0.03 mm	T	0.85 ± 0.10 mm
E	1.60 ± 0.20 mm	M	0.95 ± 0.10 mm	U	0.50 ± 0.10 mm
F	2.00 ± 0.20 mm	N	0.50 ± 0.05 mm	V	0.20 ± 0.02 mm
G	2.50 ± 0.30 mm	O	3.50 ± 0.20 mm	X	0.80 ± 0.10 mm
H	2.80 ± 0.30 mm	P	1.60 +0.3/-0.10 mm	Z	0.25 ± 0.03 mm

Table 5		Tolerance			
Code	Description	Code	Description	Code	Description
A	±0.05 pF	I	-10% ~ 0%	Q	±0.03 pF
B	±0.10 pF	J	±5 %	Z	-20% ~ +80%
C	±0.25 pF	K	±10 %	X	+10% ~ +20%
D	±0.50 pF	L	0% ~ +10%		
F	±1 %	M	±20 %		
G	±2 %	N	-5% ~ +10%		
H	±3 %	P	±0.02 pF		

Table 9		Special Control Code	
Code	Description	Code	Description
G	RoHS Compliant	H	High reliability
		Q	Surface Coating (Size 1206~2225)

5. EXTERNAL DIMENSIONS

Size Inch (mm)	L (mm)	W (mm)	Code / T (mm)	M _B (mm)	
0402(1005)	1.00±0.20	0.50±0.20	See No.4 Reference Table 8	0.25 +0.05/-0.10	
0603(1608)	1.60±0.20	0.80±0.20		0.40±0.15	
0805(2012)	2.10±0.20	1.25±0.20		0.50±0.20	
1206(3216)	3.30±0.30	1.60±0.20 1.60 +0.30/-0.10 [#]		0.60±0.20	
1210(3225)	3.30±0.40	2.50±0.30		0.75±0.35	
1808(4520)	4.60±0.50	2.00±0.25		0.75±0.35	
1812(4532)	4.60±0.50	3.20±0.30		0.75±0.35	
1825(4563)	4.60±0.50	6.30±0.40		0.75±0.35	
2220(5750)	5.70±0.50	5.00±0.40		0.85±0.35	
2225(5763)	5.70±0.50				

Fig. 5.1 The outline of MLCC

[#] For 1206 size P thickness product

6. GENERAL ELECTRICAL DATA

Dielectric	C0G	X7R												
Size	0402, 0603, 0805, 1206, 1210, 1808, 1812, 1825, 2220, 2225	0402, 0603, 0805, 1206, 1210, 1808, 1812, 1825, 2220, 2225												
Rated voltage (WVDC)	5V, 6V, 16V, 25V, 50V, 100V, 200V, 250V, 500V, 630V, 1KV, 1.5KV, 2KV, 3KV, 4KV	6.3V, 10V, 16V, 25V, 50V, 100V, 200V, 250V, 500V, 630V, 1KV, 1.5KV, 2KV, 3KV, 4KV												
Capacitance range	0.1pF ~ 330nF	100pF ~ 22μF												
Capacitance tolerance	Reference to Table 5	Reference to Table 5												
Tan	<table border="1"> <thead> <tr> <th>Cap. Range</th> <th>Q Spec.</th> </tr> </thead> <tbody> <tr> <td></td> <td>Q 400+20C</td> </tr> <tr> <td></td> <td>Q 100</td> </tr> </tbody> </table>	Cap. Range	Q Spec.		Q 400+20C		Q 100	Reference to 8. RELIABILITY TEST CONDITIONS AND REQUIREMENTS						
Cap. Range	Q Spec.													
	Q 400+20C													
	Q 100													
Capacitance & Tan Test condition	For 25°C at ambient temperature	Preconditioning for Class II MLCC : Perform a heat treatment at 150±10°C for 1 hour, then leave in ambient condition for 24±2 hours before measurement												
	<table border="1"> <thead> <tr> <th>Cap. Range</th> <th>Test Condition</th> </tr> </thead> <tbody> <tr> <td>Cap. 1000pF</td> <td>1.0±0.2Vrms, 1.0MHz±10%</td> </tr> <tr> <td>Cap.>1000pF</td> <td>1.0±0.2Vrms, 1.0KHz±10%</td> </tr> </tbody> </table>	Cap. Range	Test Condition	Cap. 1000pF	1.0±0.2Vrms, 1.0MHz±10%	Cap.>1000pF	1.0±0.2Vrms, 1.0KHz±10%	<table border="1"> <thead> <tr> <th>Cap. Range</th> <th>Test Condition</th> </tr> </thead> <tbody> <tr> <td>Cap. 10μF</td> <td>1.0±0.2Vrms, 1.0KHz±10%</td> </tr> <tr> <td>Cap.>10μF</td> <td>0.5±0.2Vrms, 120Hz±20%</td> </tr> </tbody> </table>	Cap. Range	Test Condition	Cap. 10μF	1.0±0.2Vrms, 1.0KHz±10%	Cap.>10μF	0.5±0.2Vrms, 120Hz±20%
Cap. Range	Test Condition													
Cap. 1000pF	1.0±0.2Vrms, 1.0MHz±10%													
Cap.>1000pF	1.0±0.2Vrms, 1.0KHz±10%													
Cap. Range	Test Condition													
Cap. 10μF	1.0±0.2Vrms, 1.0KHz±10%													
Cap.>10μF	0.5±0.2Vrms, 120Hz±20%													
Insulation resistance	10G or RxC 500 -F, whichever is smaller	10G or RxC 100 -F, whichever is smaller												
Operating temperature	-55°C to +125°C	-55°C to +125°C												
Temperature coefficient	±30ppm/°C	±15%												
Termination	Cu/Ag polymer/Ni/Sn(lead-free termination)	Cu/Ag polymer/Ni/Sn(lead-free termination)												

7. CAPACITANCE RANGE

7-1. C0G

Dimension	Code	0402					0603							0805										
		10V	16V	25V	50V	100V	10V	16V	25V	50V	100V	200V	250V	10V	16V	25V	50V	100V	200V	250V	500V	630V	1000V	
0.1	0R1	K	K	K	K																			
0.2	0R2	K	K	K	K																			
0.3	0R3	K	K	K	K		S	S	S	S														
0.4	0R4	K	K	K	K		S	S	S	S														
0.5	0R5	K	K	K	K	K	S	S	S	S	S	S	A	A	A	A	A	A	A	A	A	A	A	C
0.6	0R6	K	K	K	K	K	S	S	S	S	S	S	A	A	A	A	A	A	A	A	A	A	A	C
0.7	0R7	K	K	K	K	K	S	S	S	S	S	S	A	A	A	A	A	A	A	A	A	A	A	C
0.8	0R8	K	K	K	K	K	S	S	S	S	S	S	A	A	A	A	A	A	A	A	A	A	A	C
0.9	0R9	K	K	K	K	K	S	S	S	S	S	S	A	A	A	A	A	A	A	A	A	A	A	C
1.0	1R0	K	K	K	K	K	S	S	S	S	S	S	A	A	A	A	A	A	A	A	A	A	A	C
1.2	1R2	K	K	K	K	K	S	S	S	S	S	S	A	A	A	A	A	A	A	A	A	A	A	C
1.5	1R5	K	K	K	K	K	S	S	S	S	S	S	A	A	A	A	A	A	A	A	A	A	A	C
1.8	1R8	K	K	K	K	K	S	S	S	S	S	S	A	A	A	A	A	A	A	A	A	A	A	C
2.2	2R2	K	K	K	K	K	S	S	S	S	S	S	A	A	A	A	A	A	A	A	A	A	A	C
2.7	2R7	K	K	K	K	K	S	S	S	S	S	S	A	A	A	A	A	A	A	A	A	A	A	C
3.3	3R3	K	K	K	K	K	S	S	S	S	S	S	A	A	A	A	A	A	A	A	A	A	A	C
3.9	3R9	K	K	K	K	K	S	S	S	S	S	S	A	A	A	A	A	A	A	A	A	A	A	C
4.7	4R7	K	K	K			S	S	S	S			A	A	A	A	A	A	A	A	A	A	A	C
5.0	5R0	K	K	K			S	S	S	S	S		A	A	A	A	A	A	A	A	A	A	A	C
5.6	5R6	K	K	K			S	S	S	S	S		A	A	A	A	A	A	A	A	A	A	A	C
6.8	6R8	K	K	K			S	S	S	S	S	S	A	A	A	A	A	A	A	A	A	A	A	C
8.2	8R2	K	K	K			S	S	S	S	S	S	A	A	A	A	A	A	A	A	A	A	A	C
10	100	K	K	K			S	S	S	S	S	S	A	A	A	A	A	A	A	A	A	A	A	C
12	120	K	K	K			S	S	S	S	S	S	A	A	A	A	A	A	A	A	A	A	A	C
15	150	K	K	K			S	S	S	S	S	S	A	A	A	A	A	A	A	A	A	A	A	C
18	180	K	K	K			S	S	S	S	S	S	A	A	A	A	A	A	A	A	A	A	A	C
22	220	K	K	K			S	S	S	S	S	S	A	A	A	A	A	A	A	A	A	A	A	C
27	270	K	K	K			S	S	S	S	S	S	A	A	A	A	A	A	A	A	A	A	A	C
33	330	K	K	K			S	S	S	S	S	S	A	A	A	A	A	A	A	A	A	A	A	C
39	390	K	K	K			S	S	S	S	S	S	A	A	A	A	A	A	A	A	A	A	A	C
47	470	K	K	K			S	S	S	S	S	S	A	A	A	A	A	A	A	A	A	A	A	C
56	560	K	K	K			S	S	S	S	S	S	A	A	A	A	A	A	A	A	A	A	A	C
68	680	K	K	K			S	S	S	S	S	S	A	A	A	A	A	A	A	A	A	A	A	C
82	820	K	K	K			S	S	S	S	S	S	A	A	A	A	A	A	A	X	X	X	X	C
100	101	K	K	K			S	S	S	S	S	S	A	A	A	A	A	A	X	X	X	X	C	C
120	121	K	K	K			S	S	S	S	S	S	A	A	A	A	A	X	C	C	C	C	C	C
150	151	K	K	K			S	S	S	S	S	S	A	A	A	A	X	X	C	C	C	C	C	C
180	181	K	K	K			S	S	S	S	S	S	A	A	A	A	X	C	C	C	C	C	C	C
220	221	K	K	K			S	S	S	S	S	S	A	A	A	A	C	C	C	C	C	C	C	C
270	271	K	K	K	K		S	S	S	S	S	B	B	A	A	A	A	A	C	C	C	C	C	C
330	331	K	K	K	K		S	S	S	S	S	B	B	A	A	A	A	A	C	C	C	C	C	C
390	391	K	K	K	K		S	S	S	S	S	B	B	X	X	X	X	X	C	C	C	C	C	C
470	471	K	K	K	K		S	S	S	S	S	B	B	X	X	X	X	X	C	C	I	I	I	
560	561	K	K	K	K		S	S	S	S	S			X	X	X	X	X	C	C	I	I	I	
680	681	K	K	K	K		S	S	S	S	S			X	X	X	X	X	C	C	I	I	I	
820	821	K	K	K	K		S	S	S	S	S			X	X	X	X	X	C	C	I	I	I	
1000	102	K	K	K	K		S	S	S	S	S			X	X	X	X	X	C	C	I	I	I	
1200	122						B	B	B	B				X	X	X	X	X	C	C				
1500	152						B	B	B	B				X	X	X	X	X	C	C				
1800	182						B	B	B	B				X	X	X	X	X	C	C				
2200	222						B	B	B	B				X	X	X	X	X	C	C				
2700	272						B	B	B	B				C	C	C	C	C	C	C				
3300	332						B	B	B	B				C	C	C	C	C	C					
3900	392													C	C	C	C	C						
4700	472													C	C	C	C	C						
5600	562													C	C	C	C	C						
6800	682													C	C	C	C	C						
8200	822													C	C	C	C	C						
10000	103													C	C	C	C	C						

7. CAPACITANCE RANGE(Con.)

7-1. C0G

Dimension		1206										1210										
Cap.(pF)	Code	10V 16V 25V	50V	100V	200V	250V	500V	630V	1000V	1500V	2000V	10V 16V 25V	50V	100V	200V	250V	500V	630V	1000V	1500V	2000V	
1.0	1R0		X																			
1.2	1R2	X	X	X			X															
1.5	1R5	X	X	X	X	X	X	X	X	X	X											
1.8	1R8	X	X	X	X	X	X	X	X	X	X											
2.2	2R2	X	X	X	X	X	X	X	X	X	X											
2.7	2R7	X	X	X	X	X	X	X	X	X	X											
3.3	3R3	X	X	X	X	X	X	X	X	X	X											
3.9	3R9	X	X	X	X	X	X	X	X	X	X											
4.7	4R7	X	X	X	X	X	X	X	X	X	X											
5.0	5R0	X	X	X	X	X	X	X	X	X	X											
5.6	5R6	X	X	X	X	X	X	X	X	X	X											
6.8	6R8	X	X	X	X	X	X	X	X	X	X											
8.2	8R2	X	X	X	X	X	X	X	X	X	X											
10	100	X	X	X	X	X	X	X	X	X	X	M	M	M	M	M	M	M	M	M	M	M
12	120	X	X	X	X	X	X	X	X	X	X	M	M	M	M	M	M	M	M	M	M	M
15	150	X	X	X	X	X	X	X	X	X	X	M	M	M	M	M	M	M	M	M	M	M
18	180	X	X	X	X	X	X	X	X	X	X	M	M	M	M	M	M	M	M	M	M	M
22	220	X	X	X	X	X	X	X	X	X	X	M	M	M	M	M	M	M	M	M	M	M
27	270	X	X	X	X	X	X	X	X	X	X	M	M	M	M	M	M	M	M	M	M	M
33	330	X	X	X	X	X	X	X	X	X	X	M	M	M	M	M	M	M	M	M	M	M
39	390	X	X	X	X	X	X	X	X	X	X	M	M	M	M	M	M	M	M	M	M	M
47	470	X	X	X	X	X	X	X	X	X	X	M	M	M	M	M	M	M	M	M	M	M
56	560	X	X	X	X	X	X	X	M	C	C	M	M	M	M	M	M	M	M	M	C	C
68	680	X	X	X	X	X	X	X	M	C	C	M	M	M	M	M	M	M	M	M	C	C
82	820	X	X	X	X	X	X	X	C	C	C	M	M	M	M	M	M	M	M	M	C	C
100	101	X	X	X	X	X	X	X	C	C	C	M	M	M	M	M	M	M	M	M	C	C
120	121	X	X	X	X	X	X	X	C	E	E	M	M	M	M	M	M	M	M	M	C	C
150	151	X	X	X	X	X	X	X	C	E	E	M	M	M	M	M	M	M	M	M	C	E
180	181	X	X	X	X	X	X	X	E	E	E	M	M	M	M	M	M	M	M	M	C	E
220	221	X	X	X	X	X	X	X	E	E	E	M	M	M	M	M	M	M	M	M	E	E
270	271	X	X	X	X	X	X	M	M	E	P	P	M	M	M	M	M	M	M	M	E	F
330	331	X	X	X	X	X	X	M	M	E	P	P	M	M	M	M	M	M	M	M	E	F
390	391	X	X	X	X	X	X	M	M	E	P	P	M	M	M	M	M	M	M	M	E	G
470	471	X	X	X	X	X	X	M	M	E	P	P	M	M	M	M	M	M	M	M	E	G
560	561	X	X	X	X	X	X	M	M	C	E	E	M	M	M	M	M	M	M	M	E	G
680	681	X	X	X	X	X	X	M	M	C	E	E	M	M	M	M	M	M	M	M	E	G
820	821	X	X	X	X	X	X	M	M	C	E	E	M	M	M	M	M	M	M	M	E	G
1000	102	X	X	X	M	E	E	E	E	E	E	M	M	M	C	C	C	C	C	E	G	G
1200	122	X	X	X	M	E	E	E	E	E	E	M	M	M	C	C	C	C	C	E	F	F
1500	152	X	X	X	C	E	E	E	E	E	E	M	M	M	C	C	C	C	C	F	G	G
1800	182	X	X	X	C	E	E	E	E	E	E	M	M	M	C	C	C	C	C	G	G	G
2200	222	X	X	X	C	E	E	E	E	E	E	M	M	M	C	C	C	C	C	G		
2700	272	X	X	X	C	E	E	E	E	E	E	M	M	M	C	C	C	C	C	G		
3300	332	X	X	X	C	E	E	E	E	E	E	M	M	M	C	C	C	C	C	G		
3900	392	X	X	X	E	E	E	E	E	E	E	M	M	M	C	C	C	C	C	G		
4700	472	X	X	X	E	E	E	E	E	E	E	M	M	M	E	E	E	E	E			
5600	562	X	X	X	E	E	E	E	E	E	E	M	M	C	E	E	E	E	E			
6800	682	M	M	M	E	E	E	E	E	E	E	M	M	C	E	E	E	E	E			
8200	822	C	C	C	E	E	E	E	E	E	E	M	M	C	E	E	E	E	E			
10000	103	C	C	C	E	E	E	E	E	E	E	M	M	E	F	F	F	F	F			
12000	123	P	P	P								C	C	E								
15000	153	P	P	P								C	C	F								
18000	183	P	P	P								F	F	G								
22000	223	P	P	P								F	F	G								
27000	273	P	P									G	G									
33000	333	P	P									G	G									
39000	393	P	P									G	G									
47000	473																					
56000	563																					
68000	683																					

7. CAPACITANCE RANGE(Con.)

7-1. C0G

Dimension		1808										1812														
Cap.(pF)	Code	25V 50V	100V	200V	250V	500V	630V	1000V	1500V	2000V	3000V	4000	10V 16V	25V	50V	100V	200V	250V	500V	630V	1000V	1500V	2000V	3000V		
1.0	1R0																									
1.2	1R2																									
1.5	1R5																									
1.8	1R8																									
2.2	2R2	C	C	C	C	C	C	C	C	C	C	C														
2.7	2R7	C	C	C	C	C	C	C	C	C	C	C														
3.3	3R3	C	C	C	C	C	C	C	C	C	C	C														
3.9	3R9	C	C	C	C	C	C	C	C	C	C	C														
4.7	4R7	C	C	C	C	C	C	C	C	C	C	C														
5.0	5R0	C	C	C	C	C	C	C	C	C	C	C														
5.6	5R6	C	C	C	C	C	C	C	C	C	C	C														
6.8	6R8	C	C	C	C	C	C	C	C	C	C	C														
8.2	8R2	C	C	C	C	C	C	C	C	C	C	C														
10	100	C	C	C	C	C	C	C	C	C	C	C	C	C	C	C	C	C	C	C	C	C	C	C	C	C
12	120	C	C	C	C	C	C	C	C	C	C	C	C	C	C	C	C	C	C	C	C	C	C	C	C	C
15	150	C	C	C	C	C	C	C	C	C	C	C	C	C	C	C	C	C	C	C	C	C	C	C	C	C
18	180	C	C	C	C																					
22	220	C	C	C	C																					
27	270	C	C	C	C																					
33	330	C	C	C	C																					
39	390	C	C	C	C																					
47	470	C	C	C	C																					
56	560	C	C	C	C																					
68	680	C	C	C	C																					
82	820	C	C	C	C																					
100	101	C	C	C	C																					
120	121	C	C	C	C																					
150	151	C	C	C	C																					
180	181	C	C	C	C																					
220	221	C	C	C	C																					
270	271	C	C	C	C																					
330	331	C	C	C	C																					
390	391	C	C	C	C																					
470	471	C	C	C	C																					
560	561	C	C	C	C																					
680	681	C	C	C	C																					
820	821	C	C	C	C																					
1000	102	C	C	C	C																					
1200	122	C	C	C	C																					
1500	152	C	C	C	C																					
1800	182	C	C	C	C																					
2200	222	C	C	C	C																					
2700	272	C	C	C	C																					
3300	332	C	C	C	C																					
3900	392	C	C	C	C																					
4700	472	C	C	C	C																					
5600	562	C	C	E	E																					
6800	682	C	C	E	E																					
8200	822	C	E	F	F																					
10000	103	C	E	F	F																					
12000	123	E																								
15000	153	E																								
18000	183	F																								
22000	223	F																								
27000	273																									
33000	333																									
39000	393																									
47000	473																									
56000	563																									
68000	683																									
82000	823																									
100000	104																									
120000	124																									
150000	154																									

7. CAPACITANCE RANGE(Con.)

7-1. C0G

Dimension		1825										2220										
Cap.(pF)	Code	25V 50V	100V	200V	250V	500V	630V	1000V	1500V	2000V	3000V	25V 50V	100V	200V	250V	500V	630V	1000V	1500V	2000V	3000V	4000V
10	100	F	F	F	F	F	F	F	F	F	F	F	F	F	F	F	F	F	F	F	F	
12	120	F	F	F	F	F	F	F	F	F	F	F	F	F	F	F	F	F	F	F	F	
15	150	F	F	F	F	F	F	F	F	F	F	F	F	F	F	F	F	F	F	F	F	
18	180	F	F	F	F	F	F	F	F	F	F	F	F	F	F	F	F	F	F	F	F	
22	220	F	F	F	F	F	F	F	F	F	F	F	F	F	F	F	F	F	F	F	F	
27	270	F	F	F	F	F	F	F	F	F	F	F	F	F	F	F	F	F	F	F	F	F
33	330	F	F	F	F	F	F	F	F	F	F	F	F	F	F	F	F	F	F	F	F	F
39	390	F	F	F	F	F	F	F	F	F	F	F	F	F	F	F	F	F	F	F	F	F
47	470	F	F	F	F	F	F	F	F	F	F	F	F	F	F	F	F	F	F	F	F	F
56	560	F	F	F	F	F	F	F	F	F	F	F	F	F	F	F	F	F	F	F	F	F
68	680	F	F	F	F	F	F	F	F	F	F	F	F	F	F	F	F	F	F	F	F	F
82	820	F	F	F	F	F	F	F	F	F	F	F	F	F	F	F	F	F	F	F	F	F
100	101	F	F	F	F	F	F	F	F	F	F	F	F	F	F	F	F	F	F	F	F	F
120	121	F	F	F	F	F	F	F	F	F	F	F	F	F	F	F	F	F	F	F	F	F
150	151	F	F	F	F	F	F	F	F	F	F	F	F	F	F	F	F	F	F	F	F	F
180	181	F	F	F	F	F	F	F	F	F	F	F	F	F	F	F	F	F	F	F	F	F
220	221	F	F	F	F																	
270	271	F	F	F	F																	
330	331	F	F	F	F																	G
390	391	F	F	F	F																	G
470	471	F	F	F	F																	
560	561	F	F	F	F																	
680	681	F	F	F	F																	
820	821	F	F	F	F																	
1000	102	F	F	F	F																	
1200	122	F	F	F	F																	
1500	152	F	F	F	F																	
1800	182	F	F	F	F																	
2200	222	F	F	F	F																	
2700	272	F	F	F	F																	
3300	332	F	F	F	F																	
3900	392	F	F	F	F																	
4700	472	F	F	F	F																	
5600	562	F	F	F	F																	
6800	682	F	F	F	F																	
8200	822	F	F	F	F																	
10000	103	F	F	F	F																	
12000	123	F	F	F	F																	
15000	153	F	F	F	F																	
18000	183	F	F	F	F																	
22000	223	F	F	F	F																	
27000	273	F	F	F	F																	
33000	333	F	F	F	F																	
39000	393	F	E	F	F	G																
47000	473	F	E	F	F	G																
56000	563	F	F	G	G																	
68000	683	F	F	G	G																	
82000	823	F	G																			
100000	104	G	G																			
120000	124																					
150000	154																					
180000	184																					
220000	224																					
270000	274																					
330000	334																					

7. CAPACITANCE RANGE(Con.)

7-1. C0G

Dimension		2225										
Cap.(pF)	Code	25V 50V	100V	200V	250V	500V	630V	1000V	1500V	2000V	3000V	4000V
10	100	F	F	F	F	F	F	F	F	F	F	
12	120	F	F	F	F	F	F	F	F	F	F	
15	150	F	F	F	F	F	F	F	F	F	F	
18	180	F	F	F	F	F	F	F	F	F	F	
22	220	F	F	F	F	F	F	F	F	F	F	
27	270	F	F	F	F	F	F	F	F	F	F	F
33	330	F	F	F	F	F	F	F	F	F	F	F
39	390	F	F	F	F	F	F	F	F	F	F	F
47	470	F	F	F	F	F	F	F	F	F	F	F
56	560	F	F	F	F	F	F	F	F	F	F	F
68	680	F	F	F	F	F	F	F	F	F	F	F
82	820	F	F	F	F	F	F	F	F	F	F	F
100	101	F	F	F	F	F	F	F	F	F	F	F
120	121	F	F	F	F	F	F	F	F	F	F	
150	151	F	F	F	F	F	F	F	F	F	F	
180	181	F	F	F	F	F	F	F	F	F	F	
220	221	F	F	F	F				F	F		
270	271	F	F	F	F				F	F	F	
330	331	F	F	F	F			F	F	F	F	
390	391	F	F	F	F			F	F	F	F	
470	471	F	F	F	F			F	F	F	F	
560	561	F	F	F	F			F	F	F	F	
680	681	F	F	F	F			F	F	F	F	
820	821	F	F	F	F			F	F	F	F	
1000	102	F	F	F	F			F	F	F	F	
1200	122	F	F	F	F			F	F	F	F	
1500	152	F	F	F	F			F	F	F	F	
1800	182	F	F	F	F			F	F	F	F	
2200	222	F	F	F	F			F	F	F	F	
2700	272	F	F	F	F			F	F	F	F	G
3300	332	F	F	F	F			F	F	F	F	G
3900	392	F	F	F	F			F	F	F	F	
4700	472	F	F	F	F			F	F	F	F	
5600	562	F	F	F	F			F	F	F	F	
6800	682	F	F	F	F			F	F	F	F	
8200	822	F	F	F	F			F	G	G		
10000	103	F	F	F	F			G	G			
12000	123	F	F	F	F							
15000	153	F	F	F	F							
18000	183	F	F	F	F							
22000	223	F	F	F	F							
27000	273	F	F	F	F							
33000	333	F	F	F	F							
39000	393	F	F	F	F							
47000	473	F	F	F	F							
56000	563	F	F	G	G	G	G					
68000	683	F	F	G	G	G	G					
82000	823	F	F	G	G	G						
100000	104	F	G	G	G							
120000	124											
150000	154											
180000	184											
220000	224											
270000	274											
330000	334											

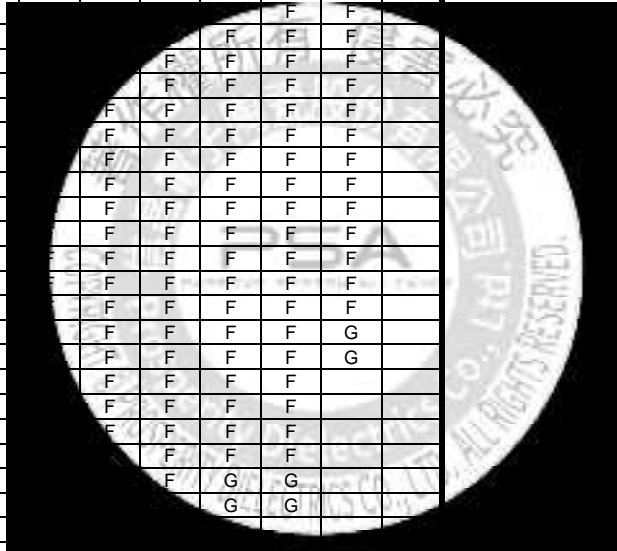

7. CAPACITANCE RANGE(Con.)

7-2. X7R

Dimension		0402						0603						0805													
Cap.(pF)	Code	6.3V	10V	16V	25V	50V	100V	6.3V	10V	16V	25V	50V	100V	200V	250V	6.3V	10V	16V	25V	50V	100V	200V	250V	500V	630V	1000V	
100	101		K	K	K	K	K		S	S	S	S	S	B	B		C	C	C	C	C	C	C	C	X	X	X
120	121		K	K	K	K	K		S	S	S	S	S	B	B		C	C	C	C	C	C	C	C	X	X	X
150	151		K	K	K	K	K		S	S	S	S	S	B	B		C	C	C	C	C	C	C	C	X	X	X
180	181		K	K	K	K	K		S	S	S	S	S	B	B		C	C	C	C	C	C	C	C	X	X	X
220	221		K	K	K	K	K		S	S	S	S	S	B	B		C	C	C	C	C	C	C	C	X	X	X
270	271		K	K	K	K	K		S	S	S	S	S	B	B		C	C	C	C	C	C	C	C	X	X	X
330	331		K	K	K	K	K		S	S	S	S	S	B	B		C	C	C	C	C	C	C	C	X	X	X
390	391		K	K	K	K	K		S	S	S	S	S	B	B		C	C	C	C	C	C	C	C	X	X	X
470	471		K	K	K	K	K		S	S	S	S	S	B	B		C	C	C	C	C	C	C	C	X	X	X
560	561		K	K	K	K	K		S	S	S	S	S	B	B		C	C	C	C	C	C	C	C	X	X	X
680	681		K	K	K	K	K		S	S	S	S	S	B	B		C	C	C	C	C	C	C	C	X	X	X
820	821		K	K	K	K	K		S	S	S	S	S	B	B		C	C	C	C	C	C	C	C	X	X	X
1000	102		K	K	K	K	K		S	S	S	S	S	B	B		C	C	C	C	C	C	C	C	X	X	X
1200	122		K	K	K	K	K		S	S	S	S	S	B	B		C	C	C	C	C	C	C	C	X	X	X
1500	152		K	K	K	K	K		S	S	S	S	S	B	B		C	C	C	C	C	C	C	C	X	X	C
1800	182		K	K	K	K	K		S	S	S	S	S	B	B		C	C	C	C	C	C	C	C	X	X	C
2200	222		K	K	K	K	K		S	S	S	S	S	B	B		C	C	C	C	C	C	C	C	X	X	C
2700	272		K	K	K				S	S	S	S	S	B	B		C	C	C	C	C	C	C	C	X	X	
3300	332		K	K	K				S	S	S	S	S	B	B		C	C	C	C	C	C	C	C	X	X	
3900	392		K	K	K				S	S	S	S	S	B	B		C	C	C	C	C	C	C	C	X	X	
4700	472		K	K	K				S	S	S	S	S	B	B		C	C	C	C	C	C	C	C	X	X	
5600	562		K	K	K				S	S	S	S	S	B	B		C	C	C	C	C	C	C	C	X	X	
6800	682		K	K	K				S	S	S	S	S	B	B		C	C	C	C	C	C	C	C	X	X	
8200	822		K	K	K				S	S	S	S	S	B	B		C	C	C	C	C	C	C	C	X	X	
10000	103		K	K	K				S	S	S	S	S	B	B		C	C	C	C	C	C	C	C	X	X	
12000	123		K	K	K				S	S	S	S	B				C	C	C	C	C	C	C	C	X	X	
15000	153		K	K	K				S	S	S	S	B				C	C	C	C	C	C	C	C	X	X	
18000	183		K	K	K				S	S	S	S	B				C	C	C	C	C	C	C	C	X	X	
22000	223		K	K	K				S	S	S	S	B				C	C	C	C	C	C	C	C	X	X	
27000	273		K	K	K				S	S	S	S	B				C	C	C	C	C	C	C	C	X	X	
33000	333		K	K	K				S	S	S	B	B				C	C	C	C	C	C	C	C	X	X	
39000	393		K	K	K				S	S	S	B	B				C	C	C	C	C	C	C	C	X	X	
47000	473		K	K	K				S	S	S	B	B				C	C	C	C	C	C	C	C	X	X	
56000	563		K	K					S	S	S	B	B				C	C	C	C	C	C	C	C	X	X	
68000	683		K	K					S	S	S	B	B				C	C	C	C	C	C	C	C	X	X	
82000	823		K	K					S	S	S	B	B				C	C	C	C	C	C	C	C	X	X	
100000	104	K	K	K					S	S	S	B	B				C	C	C	C	C	C	C	C	X	X	
120000	124								S	S	B						C	C	I								
150000	154								S	S	B						C	C	I								
180000	184								S	S	B						C	C	C	C	I						
220000	224								S	S	B	B					C	C	C	C	I						
270000	274							B	B	B	B						I	I	I	I							
330000	334								B	B	B						I	I	I	I							
390000	394								B	B	B						I	I	I	I							
470000	474							B	B	B	B						I	I	I	I	I						
560000	564								B	B							I	I	I								
680000	684							B	B	B							I	I	I								
820000	824								B	B							I	I	I								
1000000	105							B	B	B							I	I	I	I							
1200000	125																I	I	I								
1500000	155																I	I	I								
2200000	225															I	I	I	I								
4700000	475																I	I	I								

7. CAPACITANCE RANGE(Con.)

7-2. X7R

Dimension		1206												1210												
Cap.(pF)	Code	6.3V	10V	16V	25V	50V	100V	200V	250V	500V	630V	1000V	1500V	2000V	10V	16V	25V	50V	100V	200V	250V	500V	630V	1000V	1500V	2000V
100	101							C	C	C	C	C	C	C												
120	121							C	C	C	C	C	C	C												
150	151		C	C	C	C	C	C	C	C	C	C	C	C												
180	181		C	C	C	C	C	C	C	C	C	C	C	C												
220	221		C	C	C	C	C	C	C	C	C	C	C	C			M	M	M	M	M	M	M	M	M	M
270	271		C	C	C	C	C	C	C	C	C	C	C	C			M	M	M	M	M	M	M	M	M	M
330	331		C	C	C	C	C	C	C	C	C	C	C	C			M	M	M	M	M	M	M	M	M	M
390	391		C	C	C	C	C	C	C	C	C	C	C	C			M	M	M	M	M	M	M	M	M	M
470	471		C	C	C	C	C	C	C	C	C	C	C	C			M	M	M	M	M	M	M	M	M	M
560	561		C	C	C	C	C	C	C	C	C	C	C	C			M	M	M	M	M	M	M	M	M	M
680	681		C	C	C	C	C	C	C	C	C	C	C	C			M	M	M	M	M	M	M	M	M	M
820	821		C	C	C	C	C	C	C	C	C	C	C	C			M	M	M	M	M	M	M	M	M	M
1000	102		C	C	C	C	C	C	C	C	C	C	C	C	M	M	M	M	M	M	M	M	M	M	C	C
1200	122		C	C	C	C	C	C	C	C	C	C	E	E	M	M	M	M	M	M	M	M	M	M	E	E
1500	152		C	C	C	C	C	C	C	C	C	C	E	E	M	M	M	M	M	M	M	M	M	M	E	E
1800	182		C	C	C	C	C	C	C	C	C	C	E	E	M	M	M	M	M	M	M	M	M	M	E	E
2200	222		C	C	C	C	C	C	C	C	C	C	E	E	M	M	M	M	M	M	M	M	M	M	F	F
2700	272		C	C	C						C	C	E	E	M	M	M	M	M	M	M	M	M	M	F	G
3300	332		C	C	C						C	C	E	E	M	M	M	M	M	M	M	M	M	M	F	G
3900	392		C	C	C						C	C	E	E	M	M	M	M	M	M	M	M	M	M	G	G
4700	472		C	C	C						C	C	E	E	M	M	M	M	M	M	M	M	M	M	G	G
5600	562		C	C	C						C	C	E	E	M	M	M	M	M	M	M	M	M	M	G	G*
6800	682		C	C	C						C	C	E	E	M	M	M	M	M	M	M	M	M	M	G	G*
8200	822		C	C	C						C	C	E	E	M	M	M	M	M	M	M	M	M	M	G	G*
10000	103		C	C	C						C	C	E	E	M	M	M	M	M	M	M	M	M	C		
12000	123		C	C	C						C	C	E	E	M	M	M	M	M	M	M	M	M	C		
15000	153		C	C	C						C	C	E	E	M	M	M	M	M	M	M	M	M	E		
18000	183		C	C	C						C	C	E	E	M	M	M	M	M	M	M	M	C	C	E	
22000	223		C	C	C						C	C	E	E	M	M	M	M	M	M	M	M	C	C	E	
27000	273		C	C	C						C	C	E	E	M	M	M	M	M	M	M	M	C	C	E	
33000	333		C	C	C						C	E	E	E	E	M	M	M	M	M	M	E	E	E		
39000	393		C	C	C						C	E	E	E	E	M	M	M	M	M	M	E	E	F		
47000	473		C	C	C						E	E	E	E	E	M	M	M	M	M	C	C	E	E	G	
56000	563		C	C	C						E	E	E	E	E	M	M	M	M	C	C	E	E			
68000	683		C	C	C						E	E	E	E	E	M	M	M	M	E	E	F	F			
82000	823		C	C	C						E	E	E	E	E	M	M	M	M	E	E	F	F			
100000	104		C	C	C						E	E	E	E	E	M	M	M	M	E	E	F	F			
120000	124		C	C	C						E	E	E	E	E	M	M	M	M	E	E					
150000	154		M	M	M										M	M	M	M	C	E	E					
180000	184		M	M	M	M	E								M	M	M	M	C	E	E					
220000	224		M	M	M	M	E								M	M	M	M	C	E	E					
270000	274		M	M	M	C	E								M	M	M	M	E	F	F					
330000	334		M	M	M	C	E								M	M	M	M	C	E	F	F				
390000	394		M	M	J	P	E								M	M	M	C	G	G	G					
470000	474		J	J	J	P	E								M	M	M	C	G	G	G					
560000	564		J	J	J	P	P								C	C	C	C	G	G	G					
680000	684		J	J	J	P	P								C	C	C	C	F	G	G					
820000	824		J	J	J	P	P								C	C	C	C	F							
1000000	105		J	J	J	P	P								C	C	C	C	F							
1200000	125																									
1500000	155	J	J	J	P	P										F	E	G	G							
1800000	185																									
2200000	225	J	J	J	P	P										F	E	G	G							
2700000	275																									
3300000	335		P	P	P											F	E	G	G							
3900000	395																									
4700000	475	P	P	P	P										F	F	F	G								
10000000	106	P	P	P	P										F	F	G	G								
22000000	226		P												G											

* Surface coating only.

7. CAPACITANCE RANGE(Con.)

7-2. X7R

Dimension		1808							1812													
Cap.(pF)	Code	500V	630V	1000V	1500V	2000V	3000V	4000V	10V 16V	25V 50V	100V	200V	250V	400V	500V	630V	1000V	1500V	2000V	3000V	4000V	
100	101																					
120	121																					
150	151	C	C	C	C	C	C	F*														
180	181	C	C	C	C	C	C	F*														
220	221	C	C	C	C	C	C	F*														
270	271	C	C	C	C	C	C	F*		C	C	C	C	C	C	C	C	C	C	C	C	F*
330	331	C	C	C	C	C	C	F*		C	C	C	C	C	C	C	C	C	C	C	C	F*
390	391	C	C	C	C	C	C	F*		C	C	C	C	C	C	C	C	C	C	C	C	F*
470	471	C	C	C	C	C	C	F*		C	C	C	C	C	C	C	C	C	C	C	C	F*
560	561	C	C	C	C	C	E	F*		C	C	C	C	C	C	C	C	C	C	C	C	F*
680	681	C	C	C	C	C	E	F*		C	C	C	C	C	C	C	C	C	C	C	C	F*
820	821	C	C	C	C	C	E	F*		C	C	C	C	C	C	C	C	C	C	C	C	F*
1000	102	C	C	C	C	C	F	F*		C	C	C	C	C	C	C	C	C	C	E	F*	
1200	122	C	C	C	C	C	F			C	C	C	C	C	C	C	C	C	C	F	G*	
1500	152	C	C	C	C	C	F			C	C	C	C	C	C	C	C	C	C	F	G*	
1800	182	C	C	C	C	C	F			C	C	C	C	C	C	C	C	C	C	G	G*	
2200	222	C	C	C	E					C	C	C	C	C	C	C	C	C	C	G	G*	
2700	272	C	C	C	F					C	C	C	C	C	C	C	C	C	C	G	G*	
3300	332	C	C	C	F					C	C	C	C	C	C	C	C	C	C	E	E	G*
3900	392	C	C	C	F					C	C	C	C	C	C	C	C	C	F	F		
4700	472	C	C	C	F					C	C	C	C	C	C	C	C	C	F	F		
5600	562	C	C	C	F					C	C	C	C	C	C	C	C	C	G	G		
6800	682	C	C	C	F					C	C	C	C	C	C	C	C	C	G	G		
8200	822	C	C	C						C	C	C	C	C	C	C	C	C	G	G		
10000	103	C	C	C						C	C	C	C	C	C	C	C	C	G	G		
12000	123	E	E	E						C	C	C	C	C	C	C	C	C				
15000	153	E	E	E						C	C	C	C	C	C	C	C	C				
18000	183	F	F	F						C	C	C	C	C	C	C	C	C	E	E		
22000	223	F	F	F						C	C	C	C	C	C	C	C	C	E	E		
27000	273	F	F	F						C	C	C	C	C	C	C	C	C	F	F		
33000	333	F	F	F						C	C	C	C	C	C	C	C	C	F	F		
39000	393	F	F	F						C	C	C	C	C	C	C	C	C	G	G		
47000	473	F	F	F						C	C	C	C	C	C	C	C	C	G	G		
56000	563	F	F	F						C	C	C	C	C	C	C	C	C	G	G		
68000	683	F	F							C	C	C	C	C	C	C	C	C	G	G		
82000	823	F	F							C	C	C	C	C	C	C	C	C	G	G		
100000	104									C	C	C	C	C					G			
120000	124									C	C	C	C						G			
150000	154									C	C	C	C	C	F	F						
180000	184									C	C	C	C	C	C	G	G					
220000	224									C	C	C	C	C	C	G	G					
270000	274									C	C	C	E	E	E	G						
330000	334									C	C	C	E	E	E	G						
390000	394									C	C	C	F	F	F	G						
470000	474									C	C	C	F	F	F	G						
560000	564									C	C	C	G	G								
680000	684									C	C	C	G	G								
820000	824									C	C	C	G	G								
1000000	105									C	C	C	G	G								
1200000	125									C	C	C										
1500000	155									C	C											
1800000	185									E	E											
2200000	225									E	E											
2700000	275									F	F											
3300000	335									F	F											
3900000	395									F	F											
4700000	475									G	G											
5600000	565									G												
6800000	685									G												
8200000	825									G												
10000000	106									G												

* Surface coating only.

7. CAPACITANCE RANGE(Con.)

7-2. X7R

Dimension		1825										2220												
Cap.(pF)	Code	25V 50V	100V	200V	250V	500V	630V	1000V	1500V	2000V	3000V	4000V	25V 50V	100V	200V	250V	400V	500V	630V	1000V	1500V	2000V	3000V	4000V
100	101																							
120	121																							
150	151																							
180	181																							
220	221																							
270	271											F*												F*
330	331											F*												F*
390	391											F*												F*
470	471											F*												F*
560	561											F*												F*
680	681											F*												F*
820	821											F*												F*
1000	102	F	F	F	F	F	F	F	F	F	F	F*	F	F	F	F	F	F	F	F	F	F	F	F*
1200	122	F	F	F	F	F	F	F	F	F	F	G*	F	F	F	F	F	F	F	F	F	F	F	G*
1500	152	F	F	F	F	F	F	F	F	F	F	G*	F	F	F	F	F	F	F	F	F	F	F	G*
1800	182	F	F	F	F	F	F	F	F	F	F	G*	F	F	F	F	F	F	F	F	F	F	F	G*
2200	222	F	F	F	F							F*												F*
2700	272	F	F	F	F							F*												F*
3300	332	F	F	F	F							F*												F*
3900	392	F	F	F	F							F*												F*
4700	472	F	F	F	F							F*												F*
5600	562	F	F	F	F							G*												F*
6800	682	F	F	F	F							G*												G*
8200	822	F	F	F	F							G*												G*
10000	103	F	F	F	F							G*												G*
12000	123	F	F	F	F							G												H*
15000	153	F	F	F	F							G												H*
18000	183	F	F	F	F							G												H*
22000	223	F	F	F	F							G												H
27000	273	F	F	F	F							H												H
33000	333	F	F	F	F							H												H
39000	393	F	F	F	F							H												H
47000	473	F	F	F	F							H												H
56000	563	F	F	F	F							H												H
68000	683	F	F	F	F							H												H
82000	823	F	F	F	F							H												H
100000	104	F	F	F	F							H												H
120000	124	F	F	F	F							H												H
150000	154	F	F	F	F							H												H
180000	184	F	F	F	F							H												H
220000	224	F	F	F	F							H												H
270000	274	F	F	F	F							H												H
330000	334	F	F	F	F							H												H
390000	394	F	F	F	F							H												H
470000	474	F	F	F	F							H												H
560000	564	F	F	F	F	G	G					H												H
680000	684	F	F	F	F							H												H
820000	824	F	F	F	F							H												H
1000000	105	F	F	F	F							H												H
1200000	125	F	F	G								H												H
1500000	155	F	F	G								H												H
1800000	185	F	F	G								H												H
2200000	225	F	F	G								H												H
2700000	275	F	F									H												H
3300000	335	F	F									H												H
3900000	395	F	F									H												H
4700000	475	F	F									H												H
5600000	565	F	F									H												H
6800000	685	F	F									H												H
8200000	825	G	G									H												H
10000000	106	G	G									H												H
12000000	126											H												H
15000000	156											H												H
18000000	186											H												H
22000000	226											H												H

* Surface coating only.

7. CAPACITANCE RANGE(Con.)

7-2. X7R

Dimension		2225											
Cap.(pF)	Code	25V	50V	100V	200V	250V	500V	630V	1000V	1500V	2000V	3000V	4000V
100	101												
120	121												
150	151												
180	181												
220	221												
270	271												F*
330	331												F*
390	391												F*
470	471												F*
560	561												F*
680	681												F*
820	821												F*
1000	102	F	F	F	F	F	F	F	F	F	F	F*	F*
1200	122	F	F	F	F	F	F	F	F	F	F	F*	G*
1500	152	F	F	F	F	F	F	F	F	F	F	F*	G*
1800	182	F	F	F	F	F	F	F	F	F	F	F*	G*
2200	222	F	F	F	F	F	F	F	F	F	F	F*	
2700	272	F	F	F					F	F	F		
3300	332	F	F	F					F	F	F		
3900	392	F	F	F					F	F	F	F*	
4700	472	F	F	F					F	F	F	F*	
5600	562	F	F	F					F	F	F	G*	
6800	682	F	F	F					F	F	F	G*	
8200	822	F	F	F					F	F	F	G*	
10000	103	F	F	F					F	F	F	G*	
12000	123	F	F	F					F	F	F	G	G*
15000	153	F	F	F					F	F	F	G	G*
18000	183	F	F	F					F	F	F	G	H*
22000	223	F	F	F					F	F	F	G	G
27000	273	F	F	F					F	F	F	G	G
33000	333	F	F	F					F	F	F	G	G
39000	393	F	F	F					F	F	F	G	H
47000	473	F	F	F					F	F	F	G	H
56000	563	F	F	F					F	F	F	G	H
68000	683	F	F	F					F	F	F	G	
82000	823	F	F	F					F	F	F	G	
100000	104	F	F	F					F	F	F	G	
120000	124	F	F	F					F	F	F	H	
150000	154	F	F	F					F	F	F		
180000	184	F	F	F	F	F	F	F	H				
220000	224	F	F	F	F	F	F	F	H				
270000	274	F	F	F	F	F	F	F					
330000	334	F	F	F	F	F	F	F					
390000	394	F	F	F	F	F	F	F					
470000	474	F	F	F	F	F	F	F					
560000	564	F	F	F	F	F	F	F					
680000	684	F	F	F	F	F	F	F					
820000	824	F	F	F	F	F	F	F					
1000000	105	F	F	F	F	F	F	F					
1200000	125	F	F	F	G	G							
1500000	155	F	F	F	G	G							
1800000	185	F	F	F	G	G							
2200000	225	F	F	F	G	G							
2700000	275	F	F	F	G	G							
3300000	335	F	F	F									
3900000	395	F	F	F									
4700000	475	F	F	F									
5600000	565	F	F	F									
6800000	685	F	F	F									
8200000	825	G	G	G									
10000000	106	G	G	G									
12000000	126												
15000000	156												
18000000	186												
22000000	226												

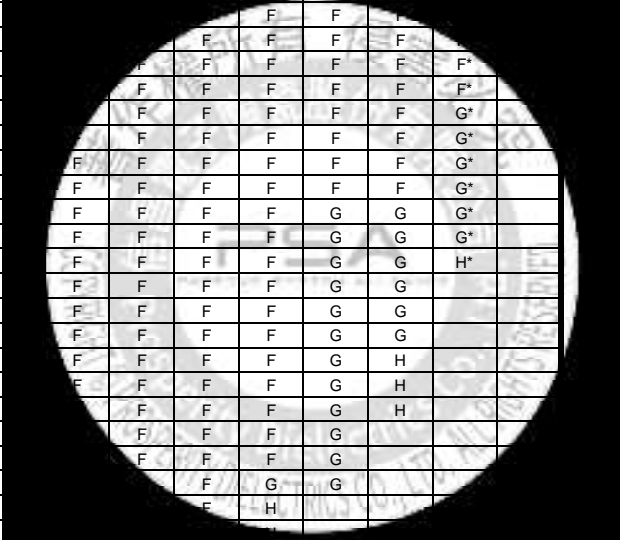

* Surface coating only.

8. RELIABILITY TEST CONDITIONS AND REQUIREMENTS

No.	Item	Test Condition	Requirements																																																											
1.	Visual and Dimensions	---	* No remarkable defect. * Dimensions to confirm to individual specification sheet.																																																											
2.	Capacitance		* Shall not exceed the limits given in the detailed spec.																																																											
3.	Q/D.F. (Dissipation Factor)	<p>* Class I :</p> <p>Cap. 1000pF, 1.0±0.2Vrms, 1MHz±10%.</p> <p>Cap.>1000pF, 1.0±0.2Vrms, 1MHz±10%.</p> <p>* Class II :</p> <p>Cap. 10µF, 1.0±0.2Vrms, 1MHz±10%.</p> <p>Cap.>10µF, 0.5±0.1Vrms, 1MHz±20%.</p> <p>** Test condition : 0.5Vrms, 1KHz±10%.</p> <p>X7R :</p> <p>0805=106(6.3V&10µF), 0603=475(6.3V).</p>	<p>* Class I :</p> <table border="1"> <thead> <tr> <th>Dielectric</th> <th>Rated Vol.(V)</th> <th>Q/D.F.</th> <th>Remark</th> </tr> </thead> <tbody> <tr> <td rowspan="2">Class I</td> <td rowspan="2">All</td> <td>Q 1000</td> <td>Cap. 30pF</td> </tr> <tr> <td>Q 400+20C</td> <td>Cap.<30pF</td> </tr> </tbody> </table> <p>* Class II :</p> <table border="1"> <thead> <tr> <th>Rated</th> <th>D.F.</th> <th colspan="2">Exception of D.F.</th> </tr> </thead> <tbody> <tr> <td rowspan="3">100V</td> <td rowspan="3">2.5%</td> <td>3.5%</td> <td>0603 0.047µF, 0805=0.1µF, 1206 0.47µF, 1812 4.7µF, 1825 4.7µF, 2220 4.7µF, 2225 4.7µF</td> </tr> <tr> <td>5%</td> <td>0603 0.068µF, 0805>0.1µF, 1206>1µF, 1210 2.2µF</td> </tr> <tr> <td>10%</td> <td>0805>0.22µF, 1210 3.3µF</td> </tr> <tr> <td rowspan="3">50V</td> <td rowspan="3">2.5%</td> <td>3.5%</td> <td>0201(50V), 0603 0.047µF, 0805 0.1µF, 1206 0.47µF, 1210 2.2µF, 1812 4.7µF, 1825 4.7µF, 2225 4.7µF</td> </tr> <tr> <td>5%</td> <td>0.01µF, 1210 4.7µF</td> </tr> <tr> <td>10%</td> <td>0.1µF, 0603>0.1µF, 0805 1µF, 1206 2.2µF, 1210 10µF</td> </tr> <tr> <td rowspan="2">35V</td> <td rowspan="2">3.5%</td> <td>10%</td> <td>0.1µF, 0805 2.2µF, 1206 2.2µF, 1210 10µF</td> </tr> <tr> <td>5%</td> <td>0.01µF, 0805 1µF, 1210 10µF</td> </tr> <tr> <td rowspan="3">25V</td> <td rowspan="3">3.5%</td> <td>7%</td> <td>0.33µF, 1206 4.7µF</td> </tr> <tr> <td>10%</td> <td>0.1µF, 0402 0.10µF, 0603 0.47µF, 2.2µF, 1206 6.8µF, 1210 22µF</td> </tr> <tr> <td>12.5%</td> <td>0.47µF</td> </tr> <tr> <td rowspan="2">16V</td> <td rowspan="2">3.5%</td> <td>5%</td> <td>0.01µF, 0402 0.033µF, 0603 0.15µF, 0.68µF, 1206 2.2µF, 1210 4.7µF</td> </tr> <tr> <td>10%</td> <td>0.1µF(0201/X7R 0.022µF), 0402 0.22µF, 0.68µF, 0805 2.2µF, 1206 4.7µF, 1210 22µF</td> </tr> <tr> <td rowspan="2">10V</td> <td rowspan="2">5%</td> <td>10%</td> <td>0.012µF, 0402 0.33µF(0402/X7R 0.22µF), 0.33µF, 0805 2.2µF, 1206 2.2µF, 1210 22µF</td> </tr> <tr> <td>15%</td> <td>0.1µF, 0402 1µF</td> </tr> <tr> <td>6.3V</td> <td>10%</td> <td>0.1µF, 0402 1µF, 0603 10µF, 0805 4.7µF, 47µF, 1210 100µF</td> </tr> </tbody> </table>	Dielectric	Rated Vol.(V)	Q/D.F.	Remark	Class I	All	Q 1000	Cap. 30pF	Q 400+20C	Cap.<30pF	Rated	D.F.	Exception of D.F.		100V	2.5%	3.5%	0603 0.047µF, 0805=0.1µF, 1206 0.47µF, 1812 4.7µF, 1825 4.7µF, 2220 4.7µF, 2225 4.7µF	5%	0603 0.068µF, 0805>0.1µF, 1206>1µF, 1210 2.2µF	10%	0805>0.22µF, 1210 3.3µF	50V	2.5%	3.5%	0201(50V), 0603 0.047µF, 0805 0.1µF, 1206 0.47µF, 1210 2.2µF, 1812 4.7µF, 1825 4.7µF, 2225 4.7µF	5%	0.01µF, 1210 4.7µF	10%	0.1µF, 0603>0.1µF, 0805 1µF, 1206 2.2µF, 1210 10µF	35V	3.5%	10%	0.1µF, 0805 2.2µF, 1206 2.2µF, 1210 10µF	5%	0.01µF, 0805 1µF, 1210 10µF	25V	3.5%	7%	0.33µF, 1206 4.7µF	10%	0.1µF, 0402 0.10µF, 0603 0.47µF, 2.2µF, 1206 6.8µF, 1210 22µF	12.5%	0.47µF	16V	3.5%	5%	0.01µF, 0402 0.033µF, 0603 0.15µF, 0.68µF, 1206 2.2µF, 1210 4.7µF	10%	0.1µF(0201/X7R 0.022µF), 0402 0.22µF, 0.68µF, 0805 2.2µF, 1206 4.7µF, 1210 22µF	10V	5%	10%	0.012µF, 0402 0.33µF(0402/X7R 0.22µF), 0.33µF, 0805 2.2µF, 1206 2.2µF, 1210 22µF	15%	0.1µF, 0402 1µF	6.3V	10%	0.1µF, 0402 1µF, 0603 10µF, 0805 4.7µF, 47µF, 1210 100µF
			Dielectric	Rated Vol.(V)	Q/D.F.	Remark																																																								
Class I	All	Q 1000	Cap. 30pF																																																											
		Q 400+20C	Cap.<30pF																																																											
Rated	D.F.	Exception of D.F.																																																												
100V	2.5%	3.5%	0603 0.047µF, 0805=0.1µF, 1206 0.47µF, 1812 4.7µF, 1825 4.7µF, 2220 4.7µF, 2225 4.7µF																																																											
		5%	0603 0.068µF, 0805>0.1µF, 1206>1µF, 1210 2.2µF																																																											
		10%	0805>0.22µF, 1210 3.3µF																																																											
50V	2.5%	3.5%	0201(50V), 0603 0.047µF, 0805 0.1µF, 1206 0.47µF, 1210 2.2µF, 1812 4.7µF, 1825 4.7µF, 2225 4.7µF																																																											
		5%	0.01µF, 1210 4.7µF																																																											
		10%	0.1µF, 0603>0.1µF, 0805 1µF, 1206 2.2µF, 1210 10µF																																																											
35V	3.5%	10%	0.1µF, 0805 2.2µF, 1206 2.2µF, 1210 10µF																																																											
		5%	0.01µF, 0805 1µF, 1210 10µF																																																											
25V	3.5%	7%	0.33µF, 1206 4.7µF																																																											
		10%	0.1µF, 0402 0.10µF, 0603 0.47µF, 2.2µF, 1206 6.8µF, 1210 22µF																																																											
		12.5%	0.47µF																																																											
16V	3.5%	5%	0.01µF, 0402 0.033µF, 0603 0.15µF, 0.68µF, 1206 2.2µF, 1210 4.7µF																																																											
		10%	0.1µF(0201/X7R 0.022µF), 0402 0.22µF, 0.68µF, 0805 2.2µF, 1206 4.7µF, 1210 22µF																																																											
10V	5%	10%	0.012µF, 0402 0.33µF(0402/X7R 0.22µF), 0.33µF, 0805 2.2µF, 1206 2.2µF, 1210 22µF																																																											
		15%	0.1µF, 0402 1µF																																																											
6.3V	10%	0.1µF, 0402 1µF, 0603 10µF, 0805 4.7µF, 47µF, 1210 100µF																																																												
4.	Temperature Coefficient	<p>* With no electrical load.</p> <table border="1"> <thead> <tr> <th>T.C.</th> <th>Operating Temp.</th> </tr> </thead> <tbody> <tr> <td>C0G</td> <td>-55~125°C at 25°C</td> </tr> <tr> <td>X7R</td> <td>-55~125°C at 25°C</td> </tr> </tbody> </table> <p>* Measurement voltage for Class II :</p> <table border="1"> <thead> <tr> <th>Size</th> <th>Cap. Range</th> <th>Condition</th> </tr> </thead> <tbody> <tr> <td rowspan="3">0201</td> <td>Cap.<0.1µF</td> <td>1V</td> </tr> <tr> <td>0.1µF Cap.<1µF</td> <td>0.2V</td> </tr> <tr> <td>Cap. 1µF</td> <td>0.1V</td> </tr> <tr> <td rowspan="4">0402</td> <td>Cap.<0.1µF</td> <td>1V</td> </tr> <tr> <td>Cap.=1µF</td> <td>0.5V</td> </tr> <tr> <td>1µF<Cap.<10µF</td> <td>0.2V</td> </tr> <tr> <td>Cap. 10µF</td> <td>0.1V</td> </tr> <tr> <td rowspan="3">0603</td> <td>Cap. 1µF</td> <td>1V</td> </tr> <tr> <td>1µF<Cap. 4.7µF</td> <td>0.5V</td> </tr> <tr> <td>Cap.>4.7µF</td> <td>0.2V</td> </tr> <tr> <td rowspan="3">0805</td> <td>Cap.<10µF</td> <td>1V</td> </tr> <tr> <td>Cap.=10µF</td> <td>0.5V</td> </tr> <tr> <td>Cap.>10µF</td> <td>0.2V</td> </tr> <tr> <td rowspan="3">1206/1210</td> <td>Cap. 10µF</td> <td>1V</td> </tr> <tr> <td>10µF<Cap. 100µF</td> <td>0.5V</td> </tr> <tr> <td>Cap.>100µF</td> <td>0.2V</td> </tr> </tbody> </table>	T.C.	Operating Temp.	C0G	-55~125°C at 25°C	X7R	-55~125°C at 25°C	Size	Cap. Range	Condition	0201	Cap.<0.1µF	1V	0.1µF Cap.<1µF	0.2V	Cap. 1µF	0.1V	0402	Cap.<0.1µF	1V	Cap.=1µF	0.5V	1µF<Cap.<10µF	0.2V	Cap. 10µF	0.1V	0603	Cap. 1µF	1V	1µF<Cap. 4.7µF	0.5V	Cap.>4.7µF	0.2V	0805	Cap.<10µF	1V	Cap.=10µF	0.5V	Cap.>10µF	0.2V	1206/1210	Cap. 10µF	1V	10µF<Cap. 100µF	0.5V	Cap.>100µF	0.2V	<table border="1"> <thead> <tr> <th>T.C.</th> <th>Capacitance Change</th> </tr> </thead> <tbody> <tr> <td>C0G</td> <td>Within ±30ppm/°C</td> </tr> <tr> <td>X7R</td> <td>Within ±15%</td> </tr> </tbody> </table>	T.C.	Capacitance Change	C0G	Within ±30ppm/°C	X7R	Within ±15%							
T.C.	Operating Temp.																																																													
C0G	-55~125°C at 25°C																																																													
X7R	-55~125°C at 25°C																																																													
Size	Cap. Range	Condition																																																												
0201	Cap.<0.1µF	1V																																																												
	0.1µF Cap.<1µF	0.2V																																																												
	Cap. 1µF	0.1V																																																												
0402	Cap.<0.1µF	1V																																																												
	Cap.=1µF	0.5V																																																												
	1µF<Cap.<10µF	0.2V																																																												
	Cap. 10µF	0.1V																																																												
0603	Cap. 1µF	1V																																																												
	1µF<Cap. 4.7µF	0.5V																																																												
	Cap.>4.7µF	0.2V																																																												
0805	Cap.<10µF	1V																																																												
	Cap.=10µF	0.5V																																																												
	Cap.>10µF	0.2V																																																												
1206/1210	Cap. 10µF	1V																																																												
	10µF<Cap. 100µF	0.5V																																																												
	Cap.>100µF	0.2V																																																												
T.C.	Capacitance Change																																																													
C0G	Within ±30ppm/°C																																																													
X7R	Within ±15%																																																													

8. RELIABILITY TEST CONDITIONS AND REQUIREMENTS

No.	Item	Test Condition	Requirements																																							
5.	Insulation Resistance	<table border="1"> <thead> <tr> <th>Rated Vol.(V)</th> <th>Apply Voltage</th> <th>Charge Time</th> </tr> </thead> <tbody> <tr> <td>100</td> <td>1 times of U_R</td> <td>Max. 120 sec.</td> </tr> <tr> <td>200 V 500</td> <td>1 times of U_R</td> <td>60 sec.</td> </tr> <tr> <td>>500</td> <td>500Vdc</td> <td>60 sec.</td> </tr> </tbody> </table>	Rated Vol.(V)	Apply Voltage	Charge Time	100	1 times of U_R	Max. 120 sec.	200 V 500	1 times of U_R	60 sec.	>500	500Vdc	60 sec.	<table border="1"> <thead> <tr> <th>Dielectric</th> <th>Capacitance Change</th> </tr> </thead> <tbody> <tr> <td>Class I</td> <td>10G or RxC 500 -F, whichever is smaller</td> </tr> <tr> <td>Class II</td> <td>10G or RxC 100 -F, whichever is smaller</td> </tr> </tbody> </table> <p>* Except (Class II) :</p> <table border="1"> <thead> <tr> <th>Rated voltage (X7R)</th> <th>I.R.</th> </tr> </thead> <tbody> <tr> <td>100V : All X7R</td> <td rowspan="10">10G or RxC 100 -F, whichever is smaller</td> </tr> <tr> <td>50V : 0402>0.01μF, 0603 1μF, 0805 1μF, 1206 4.7μF, 1210 4.7μF, 1812 10μF, 2220 22μF</td> </tr> <tr> <td>35V : 0805 2.2μF, 1206 2.2μF, 1210 10μF</td> </tr> <tr> <td>25V : 0402 1μF, 0603 2.2μF, 0805 2.2μF, 1206 10μF, 1210 10μF</td> </tr> <tr> <td>16V : 0201 0.1μF, 0402 0.22μF, 0603 1μF, 0805 2.2μF, 1206 10μF, 1210 47μF</td> </tr> <tr> <td>10V : 0201 47nF, 0402 0.47μF, 0603 0.47μF, 0805 2.2μF, 1206 4.7μF, 1210 47μF</td> </tr> <tr> <td>6.3V; 4V</td> </tr> <tr> <th>Rated voltage (X7R)</th> <th>I.R.</th> </tr> <tr> <td>100V : 1210 3.3μF</td> <td rowspan="10">RxC 50 -F</td> </tr> <tr> <td>50V : 0402 0.1μF, 0603 2.2μF, 0805 10μF, 1206 10μF</td> </tr> <tr> <td>35V : 0805 2.2μF, 1206 2.2μF, 1210 10μF</td> </tr> <tr> <td>25V : 0201 0.1μF, 0402 0.22μF, 0603 10μF, 0805 10μF, 1206 22μF</td> </tr> <tr> <td>16V : 0603 10μF, 0805 10μF, 1206 22μF</td> </tr> <tr> <td>10V : 0201>0.1μF, 0402 0.22μF, 0603 10μF, 0805 47μF</td> </tr> <tr> <td>6.3V : 0201 0.1μF, 0603 10μF, 0805 47μF, 1206 10μF</td> </tr> <tr> <td>4V : 0603 22μF, 0805 47μF, 1206 100μF</td> </tr> </tbody> </table>	Dielectric	Capacitance Change	Class I	10G or RxC 500 -F, whichever is smaller	Class II	10G or RxC 100 -F, whichever is smaller	Rated voltage (X7R)	I.R.	100V : All X7R	10G or RxC 100 -F, whichever is smaller	50V : 0402>0.01 μ F, 0603 1 μ F, 0805 1 μ F, 1206 4.7 μ F, 1210 4.7 μ F, 1812 10 μ F, 2220 22 μ F	35V : 0805 2.2 μ F, 1206 2.2 μ F, 1210 10 μ F	25V : 0402 1 μ F, 0603 2.2 μ F, 0805 2.2 μ F, 1206 10 μ F, 1210 10 μ F	16V : 0201 0.1 μ F, 0402 0.22 μ F, 0603 1 μ F, 0805 2.2 μ F, 1206 10 μ F, 1210 47 μ F	10V : 0201 47nF, 0402 0.47 μ F, 0603 0.47 μ F, 0805 2.2 μ F, 1206 4.7 μ F, 1210 47 μ F	6.3V; 4V	Rated voltage (X7R)	I.R.	100V : 1210 3.3 μ F	RxC 50 -F	50V : 0402 0.1 μ F, 0603 2.2 μ F, 0805 10 μ F, 1206 10 μ F	35V : 0805 2.2 μ F, 1206 2.2 μ F, 1210 10 μ F	25V : 0201 0.1 μ F, 0402 0.22 μ F, 0603 10 μ F, 0805 10 μ F, 1206 22 μ F	16V : 0603 10 μ F, 0805 10 μ F, 1206 22 μ F	10V : 0201>0.1 μ F, 0402 0.22 μ F, 0603 10 μ F, 0805 47 μ F	6.3V : 0201 0.1 μ F, 0603 10 μ F, 0805 47 μ F, 1206 10 μ F	4V : 0603 22 μ F, 0805 47 μ F, 1206 100 μ F
		Rated Vol.(V)	Apply Voltage	Charge Time																																						
100	1 times of U_R	Max. 120 sec.																																								
200 V 500	1 times of U_R	60 sec.																																								
>500	500Vdc	60 sec.																																								
Dielectric	Capacitance Change																																									
Class I	10G or RxC 500 -F, whichever is smaller																																									
Class II	10G or RxC 100 -F, whichever is smaller																																									
Rated voltage (X7R)	I.R.																																									
100V : All X7R	10G or RxC 100 -F, whichever is smaller																																									
50V : 0402>0.01 μ F, 0603 1 μ F, 0805 1 μ F, 1206 4.7 μ F, 1210 4.7 μ F, 1812 10 μ F, 2220 22 μ F																																										
35V : 0805 2.2 μ F, 1206 2.2 μ F, 1210 10 μ F																																										
25V : 0402 1 μ F, 0603 2.2 μ F, 0805 2.2 μ F, 1206 10 μ F, 1210 10 μ F																																										
16V : 0201 0.1 μ F, 0402 0.22 μ F, 0603 1 μ F, 0805 2.2 μ F, 1206 10 μ F, 1210 47 μ F																																										
10V : 0201 47nF, 0402 0.47 μ F, 0603 0.47 μ F, 0805 2.2 μ F, 1206 4.7 μ F, 1210 47 μ F																																										
6.3V; 4V																																										
Rated voltage (X7R)		I.R.																																								
100V : 1210 3.3 μ F		RxC 50 -F																																								
50V : 0402 0.1 μ F, 0603 2.2 μ F, 0805 10 μ F, 1206 10 μ F																																										
35V : 0805 2.2 μ F, 1206 2.2 μ F, 1210 10 μ F																																										
25V : 0201 0.1 μ F, 0402 0.22 μ F, 0603 10 μ F, 0805 10 μ F, 1206 22 μ F																																										
16V : 0603 10 μ F, 0805 10 μ F, 1206 22 μ F																																										
10V : 0201>0.1 μ F, 0402 0.22 μ F, 0603 10 μ F, 0805 47 μ F																																										
6.3V : 0201 0.1 μ F, 0603 10 μ F, 0805 47 μ F, 1206 10 μ F																																										
4V : 0603 22 μ F, 0805 47 μ F, 1206 100 μ F																																										
6.	Dielectric Strength		<table border="1"> <thead> <tr> <th>Rated Voltage</th> <th>Condition</th> </tr> </thead> <tbody> <tr> <td>100</td> <td>2.5 times of U_R</td> </tr> <tr> <td>100<V 250</td> <td>2.0 times of U_R</td> </tr> <tr> <td>250<V 500</td> <td>1.5 times of U_R</td> </tr> <tr> <td>630 V 3000V</td> <td>1.2 times of U_R</td> </tr> <tr> <td>3000<V<5000V</td> <td>1.1 times of U_R</td> </tr> <tr> <td>5000V</td> <td>1.0 times of U_R</td> </tr> </tbody> </table> <p>* Duration : 1 to 5 sec. * Charge and discharge current less than 50mA. * Test in insulating fluid for voltage 1KV products.</p>	Rated Voltage	Condition	100	2.5 times of U_R	100<V 250	2.0 times of U_R	250<V 500	1.5 times of U_R	630 V 3000V	1.2 times of U_R	3000<V<5000V	1.1 times of U_R	5000V	1.0 times of U_R	<p>* No evidence of damage or flash over during test.</p>																								
Rated Voltage	Condition																																									
100	2.5 times of U_R																																									
100<V 250	2.0 times of U_R																																									
250<V 500	1.5 times of U_R																																									
630 V 3000V	1.2 times of U_R																																									
3000<V<5000V	1.1 times of U_R																																									
5000V	1.0 times of U_R																																									
7.	Solderability	<p>* Solder temperature : 220\pm5$^{\circ}$C (180-210). * Solder temperature : 245\pm5$^{\circ}$C for (1808-2225). * Dipping time : 2\pm0.5 sec.</p>	<p>* 75% min. coverage of all metalized area.</p>																																							
8.	Resistance to Soldering Heat	<p>* Solder temperature : 260\pm5$^{\circ}$C. * Dipping time : 10\pm1 sec. * Preheating : 120 to 150$^{\circ}$C for 1 minute before immerse the capacitor in a eutectic solder. * Before initial measurement (Class II only) : To apply de-aging at 150$^{\circ}$C for 1hr then set for 24\pm2 hrs at room temp. * Measurement to be made after keeping at room temp. for 24\pm2 hrs (Class I) or 48\pm4 hrs (Class II).</p>	<p>* No remarkable damage. * Cap. change : C0G : Within \pm2.5% or \pm0.25pF, whichever is larger. X7R : Within \pm7.5%. * D.F./Q, I.R. : To meet initial requirements. * 25% max. leaching on each edge.</p>																																							
9.	Temperature Cycle	<p>* Conduct the five cycles according to the temperatures and time.</p> <table border="1"> <thead> <tr> <th>Step</th> <th>Temp.($^{\circ}$C)</th> <th>Time(min.)</th> </tr> </thead> <tbody> <tr> <td>1</td> <td>Min. operating temp. +0/-3</td> <td>30\pm3</td> </tr> <tr> <td>2</td> <td>Room temp.</td> <td>2-3</td> </tr> <tr> <td>3</td> <td>Max. operating temp. +3/-0</td> <td>30\pm3</td> </tr> <tr> <td>4</td> <td>Room temp.</td> <td>2-3</td> </tr> </tbody> </table> <p>* Before initial measurement (Class II only) : To apply de-aging at 150$^{\circ}$C for 1hr then set for 24\pm2 hrs at room temp. * Measurement to be made after keeping at room temp. for 24\pm2 hrs (Class I) or 48\pm4 hrs (Class II).</p>	Step	Temp.($^{\circ}$ C)	Time(min.)	1	Min. operating temp. +0/-3	30 \pm 3	2	Room temp.	2-3	3	Max. operating temp. +3/-0	30 \pm 3	4	Room temp.	2-3	<p>* No remarkable damage. * Cap. change : C0G : Within \pm2.5% or \pm0.25pF, whichever is larger. X7R : Within \pm7.5%. * D.F./Q : C0G : Q 100% of initial requirements. X7R : D.F. 150% of initial requirement. * I.R. : 100% of initial requirement.</p>																								
Step	Temp.($^{\circ}$ C)	Time(min.)																																								
1	Min. operating temp. +0/-3	30 \pm 3																																								
2	Room temp.	2-3																																								
3	Max. operating temp. +3/-0	30 \pm 3																																								
4	Room temp.	2-3																																								

8. RELIABILITY TEST CONDITIONS AND REQUIREMENTS

No.	Item	Test Condition	Requirements											
10.	Humidity (Damp Heat) Steady State	<ul style="list-style-type: none"> * Test temp. : 40±2°C. * Humidity : 90~95%RH. * Test time : 500 +24/-0hrs. * Before initial measurement (Class II only) : To apply de-aging at 150°C for 1hr then set for 24±2 hrs at room temp. * Measurement to be made after keeping at room temp. for 24±2 hrs (Class I) or 48±4 hrs (Class II). 	<ul style="list-style-type: none"> * No remarkable damage. * Cap. change : COG : Within ±5.0% or ±0.5pF, whichever is larger. X7R : Within ±12.5% for 10V**, within ±25% for 6.3V. **10V : Within ±25% for 0603 4.7µF, 0402 1µF. * D.F./Q : COG : Q 350 for Cap.>30pF, Q 275+2.5C for 10pF Cap. 30pF, Q 200+10C for Cap.<10pF. X7R : D.F. 200% of initial requirement. * I.R. : 10V, 1G or RxC 50 -F, whichever is smaller. <p>Except :</p> <table border="1"> <thead> <tr> <th>Rated voltage</th> <th>I.R.</th> </tr> </thead> <tbody> <tr> <td>100V : All X7R; 1210 3.3µF</td> <td rowspan="10">1G or RxC 10 -F, whichever is smaller</td> </tr> <tr> <td>50V : 0402>0.01µF, 0603 1µF, 0805 1µF, 1206 4.7µF, 1210 4.7µF</td> </tr> <tr> <td>35V : 0603 1µF, 0805 2.2µF, 1206 2.2µF, 1210 10µF</td> </tr> <tr> <td>25V : 0201 0.1µF, 0402 0.22µF, 0603 2.2µF, 0805 2.2µF, 1206 10µF, 1210 10µF</td> </tr> <tr> <td>16V : 0201 0.1µF, 0402 0.22µF, 0603 1µF, 0805 2.2µF, 1206 10µF, 1210 47µF</td> </tr> <tr> <td>10V : 0201 47nF, 0402 0.47µF, 0603 0.47µF, 0805 2.2µF, 1206 4.7µF, 1210 47µF</td> </tr> <tr> <td>6.3V; 4V; Size 1812</td> </tr> </tbody> </table>	Rated voltage	I.R.	100V : All X7R; 1210 3.3µF	1G or RxC 10 -F, whichever is smaller	50V : 0402>0.01µF, 0603 1µF, 0805 1µF, 1206 4.7µF, 1210 4.7µF	35V : 0603 1µF, 0805 2.2µF, 1206 2.2µF, 1210 10µF	25V : 0201 0.1µF, 0402 0.22µF, 0603 2.2µF, 0805 2.2µF, 1206 10µF, 1210 10µF	16V : 0201 0.1µF, 0402 0.22µF, 0603 1µF, 0805 2.2µF, 1206 10µF, 1210 47µF	10V : 0201 47nF, 0402 0.47µF, 0603 0.47µF, 0805 2.2µF, 1206 4.7µF, 1210 47µF	6.3V; 4V; Size 1812	
			Rated voltage	I.R.										
100V : All X7R; 1210 3.3µF	1G or RxC 10 -F, whichever is smaller													
50V : 0402>0.01µF, 0603 1µF, 0805 1µF, 1206 4.7µF, 1210 4.7µF														
35V : 0603 1µF, 0805 2.2µF, 1206 2.2µF, 1210 10µF														
25V : 0201 0.1µF, 0402 0.22µF, 0603 2.2µF, 0805 2.2µF, 1206 10µF, 1210 10µF														
16V : 0201 0.1µF, 0402 0.22µF, 0603 1µF, 0805 2.2µF, 1206 10µF, 1210 47µF														
10V : 0201 47nF, 0402 0.47µF, 0603 0.47µF, 0805 2.2µF, 1206 4.7µF, 1210 47µF														
6.3V; 4V; Size 1812														
11.		Humidity (Damp Heat) Load	<ul style="list-style-type: none"> * Reflow solder the capacitors on a P.C. Board before test. * Test temp. : 40±2°C (85±3°C for control code H). * Humidity : 90~95% RH (85±5% for control code H). * Test time : 500 +24/-0hrs. * To apply voltage : Rated voltage (500Vdc max. for general purpose and 100Vdc max. for control code H) * Measurement to be made after keeping at room temp. for 24±2 hrs (Class I) or 48±4 hrs (Class II). 	<ul style="list-style-type: none"> * No remarkable damage. * Cap. change : COG : Within ±7.5% or ±0.5pF, whichever is larger. X7R : Within ±12.5% for 10V**, within ±25% for 6.3V. **10V : Within ±25% for 0603 4.7µF, 0402 1µF. * D.F./Q : COG : Q 350 for Cap.>30pF, Q 275+2.5C for 10pF Cap. 30pF, Q 200+10C for Cap.<10pF. X7R : 200% of initial requirement. * I.R. : 10V, 500M or RxC 25 -F, whichever is smaller. <p>Except :</p> <table border="1"> <thead> <tr> <th>Rated voltage</th> <th>I.R.</th> </tr> </thead> <tbody> <tr> <td>100V : All X7R; 1210 3.3µF</td> <td rowspan="10">500M or RxC 5 -F, whichever is smaller</td> </tr> <tr> <td>50V : 0402>0.01µF, 0603 1µF, 0805 1µF, 1206 4.7µF, 1210 4.7µF</td> </tr> <tr> <td>35V : 0603 1µF, 0805 2.2µF, 1206 2.2µF, 1210 10µF</td> </tr> <tr> <td>25V : 0201 0.1µF, 0402 0.22µF, 0603 2.2µF, 0805 2.2µF, 1206 10µF, 1210 10µF</td> </tr> <tr> <td>16V : 0201 0.1µF, 0402 0.22µF, 0603 1µF, 0805 2.2µF, 1206 10µF, 1210 47µF</td> </tr> <tr> <td>10V : 0201 47nF, 0402 0.47µF, 0603 0.47µF, 0805 2.2µF, 1206 4.7µF, 1210 47µF</td> </tr> <tr> <td>6.3V; 4V; Size 1812</td> </tr> </tbody> </table>	Rated voltage	I.R.		100V : All X7R; 1210 3.3µF	500M or RxC 5 -F, whichever is smaller	50V : 0402>0.01µF, 0603 1µF, 0805 1µF, 1206 4.7µF, 1210 4.7µF	35V : 0603 1µF, 0805 2.2µF, 1206 2.2µF, 1210 10µF	25V : 0201 0.1µF, 0402 0.22µF, 0603 2.2µF, 0805 2.2µF, 1206 10µF, 1210 10µF	16V : 0201 0.1µF, 0402 0.22µF, 0603 1µF, 0805 2.2µF, 1206 10µF, 1210 47µF	10V : 0201 47nF, 0402 0.47µF, 0603 0.47µF, 0805 2.2µF, 1206 4.7µF, 1210 47µF
				Rated voltage	I.R.									
100V : All X7R; 1210 3.3µF		500M or RxC 5 -F, whichever is smaller												
50V : 0402>0.01µF, 0603 1µF, 0805 1µF, 1206 4.7µF, 1210 4.7µF														
35V : 0603 1µF, 0805 2.2µF, 1206 2.2µF, 1210 10µF														
25V : 0201 0.1µF, 0402 0.22µF, 0603 2.2µF, 0805 2.2µF, 1206 10µF, 1210 10µF														
16V : 0201 0.1µF, 0402 0.22µF, 0603 1µF, 0805 2.2µF, 1206 10µF, 1210 47µF														
10V : 0201 47nF, 0402 0.47µF, 0603 0.47µF, 0805 2.2µF, 1206 4.7µF, 1210 47µF														
6.3V; 4V; Size 1812														

8. RELIABILITY TEST CONDITIONS AND REQUIREMENTS

No.	Item	Test Condition	Requirements																																																																																																									
12.	High Temperature Load (Endurance)	<p>* Test temp. : 125±3°C.</p> <p>* To apply voltage :</p> <p>(1) 6.3V or Cap. 10µF : 150% of rated voltage.</p> <p>(2) 10V Ur 100V : 200% of rated voltage.</p> <p>(3) 200V Ur 500V : 150% of rated voltage.</p> <p>(4) 630V : 120% of rated voltage.</p> <p>(5) Ur 1000V : 100% of rated voltage.</p> <p>(6) 100% of rated voltage for below range :</p> <table border="1"> <thead> <tr> <th>Size</th> <th>Dielectric</th> <th>Rated</th> <th>Capacitance</th> </tr> </thead> <tbody> <tr> <td rowspan="2">0201</td> <td rowspan="2">X7R</td> <td>10V</td> <td>C 0.1µF</td> </tr> <tr> <td>16V</td> <td>C>0.1µF</td> </tr> <tr> <td>0402</td> <td>X7R</td> <td>6.3V, 10V, 16V, 25V</td> <td>C 1.0µF</td> </tr> <tr> <td rowspan="2">0603</td> <td rowspan="2">X7R</td> <td>4V</td> <td>C 22µF</td> </tr> <tr> <td>6.3V,10V</td> <td>C 4.7µF</td> </tr> <tr> <td rowspan="2">0805</td> <td rowspan="2">X7R</td> <td>25V, 35V</td> <td>C 1.0µF</td> </tr> <tr> <td>4V</td> <td>C 47µF</td> </tr> <tr> <td rowspan="2">1206</td> <td rowspan="2">X7R</td> <td>6.3V, 10V</td> <td>C 10µF</td> </tr> <tr> <td>16V</td> <td>C 47µF</td> </tr> <tr> <td rowspan="2">1210</td> <td rowspan="2">X7R</td> <td>16V</td> <td>C 47µF</td> </tr> <tr> <td>10V</td> <td>C 3.3µF</td> </tr> </tbody> </table> <p>(7) 150% of rated voltage for below range :</p> <table border="1"> <thead> <tr> <th>Size</th> <th>Dielectric</th> <th>Rated Voltage</th> <th>Capacitance</th> </tr> </thead> <tbody> <tr> <td>0201</td> <td>X7R</td> <td>10V</td> <td>C 0.022µF</td> </tr> <tr> <td rowspan="2">0402</td> <td rowspan="2">X7R</td> <td>10V</td> <td>C 0.1µF</td> </tr> <tr> <td>5V</td> <td>C 0.22µF</td> </tr> <tr> <td rowspan="2">0603</td> <td rowspan="2">X7R</td> <td>10V</td> <td>C 0.082µF</td> </tr> <tr> <td>6V, 50V</td> <td>C 1.0µF</td> </tr> <tr> <td rowspan="2">0805</td> <td rowspan="2">X7R</td> <td>10V</td> <td>C 4.7µF</td> </tr> <tr> <td>10V</td> <td>C 0.47µF</td> </tr> <tr> <td rowspan="2">1206</td> <td rowspan="2">X7R</td> <td>10V</td> <td>C 0.12µF</td> </tr> <tr> <td>10V</td> <td>C 1.0µF</td> </tr> <tr> <td rowspan="2">1210</td> <td rowspan="2">X7R</td> <td>10V</td> <td>C 1.0µF</td> </tr> <tr> <td>10V</td> <td>C 0.22µF</td> </tr> <tr> <td>1812</td> <td>X7R</td> <td>10V</td> <td>C 4.7µF</td> </tr> <tr> <td>1825</td> <td rowspan="3">X7R</td> <td rowspan="3">100V</td> <td rowspan="3">C 1.0µF</td> </tr> <tr> <td>2220</td> </tr> <tr> <td>2225</td> </tr> </tbody> </table> <p>(8) 120% of rated voltage for below range :</p> <table border="1"> <thead> <tr> <th>Size</th> <th>Dielectric</th> <th>Rated Voltage</th> <th>Capacitance</th> </tr> </thead> <tbody> <tr> <td>2220</td> <td>X7R</td> <td>100V</td> <td>C 15µF</td> </tr> </tbody> </table> <p>* Test time : 1000 +24/-0 hrs.</p> <p>* Before initial measurement (Class II only) : To apply de-aging at 150°C for 1hr then set for 24±2 hrs at room temp.</p> <p>* Measurement to be made after keeping at room temp. for 48±4 hrs (Class II).</p> <p>** De-rating conditions :</p>	Size	Dielectric	Rated	Capacitance	0201	X7R	10V	C 0.1µF	16V	C>0.1µF	0402	X7R	6.3V, 10V, 16V, 25V	C 1.0µF	0603	X7R	4V	C 22µF	6.3V,10V	C 4.7µF	0805	X7R	25V, 35V	C 1.0µF	4V	C 47µF	1206	X7R	6.3V, 10V	C 10µF	16V	C 47µF	1210	X7R	16V	C 47µF	10V	C 3.3µF	Size	Dielectric	Rated Voltage	Capacitance	0201	X7R	10V	C 0.022µF	0402	X7R	10V	C 0.1µF	5V	C 0.22µF	0603	X7R	10V	C 0.082µF	6V, 50V	C 1.0µF	0805	X7R	10V	C 4.7µF	10V	C 0.47µF	1206	X7R	10V	C 0.12µF	10V	C 1.0µF	1210	X7R	10V	C 1.0µF	10V	C 0.22µF	1812	X7R	10V	C 4.7µF	1825	X7R	100V	C 1.0µF	2220	2225	Size	Dielectric	Rated Voltage	Capacitance	2220	X7R	100V	C 15µF	<p>* No remarkable damage.</p> <p>* Cap. change :</p> <p>COG : Within ±5.0% or ±0.5pF, whichever is larger.</p> <p>X7R : Within ±12.5% for 10V**, within ±25% for 6.3V.</p> <p>**10V : Within ±25% for 0603 4.7µF, 0402 1µF.</p> <p>* D.F./Q :</p> <p>COG : Q 350 for Cap.>30pF, Q 275+2.5C for 10pF Cap. 30pF, Q 200+10C for Cap.<10pF.</p> <p>X7R : D.F. 200% of initial requirement.</p> <p>* I.R. : 10V, 1G or RxC 50 -F, whichever is smaller.</p> <p>Except :</p> <table border="1"> <thead> <tr> <th>Rated voltage</th> <th>I.R.</th> </tr> </thead> <tbody> <tr> <td>100V : All X7R; 1210 3.3µF</td> <td rowspan="6">1G or RxC 10 -F, whichever is smaller</td> </tr> <tr> <td>50V : 0402>0.01µF, 0603 1µF, 0805 1µF, 1206 4.7µF, 1210 4.7µF</td> </tr> <tr> <td>35V : 0603 1µF, 0805 2.2µF, 1206 2.2µF, 1210 10µF</td> </tr> <tr> <td>25V : 0603 1µF, 0805 2.2µF, 0805 2.2µF, 1206 10µF, 1210 10µF</td> </tr> <tr> <td>16V : 0201 0.1µF, 0603 1µF, 0805 2.2µF, 1206 10µF, 1210 47µF</td> </tr> <tr> <td>10V : 0201 47nF, 0402 1210 47µF</td> </tr> <tr> <td>6.3V; 4V; Size 1812</td> <td></td> </tr> </tbody> </table>	Rated voltage	I.R.	100V : All X7R; 1210 3.3µF	1G or RxC 10 -F, whichever is smaller	50V : 0402>0.01µF, 0603 1µF, 0805 1µF, 1206 4.7µF, 1210 4.7µF	35V : 0603 1µF, 0805 2.2µF, 1206 2.2µF, 1210 10µF	25V : 0603 1µF, 0805 2.2µF, 0805 2.2µF, 1206 10µF, 1210 10µF	16V : 0201 0.1µF, 0603 1µF, 0805 2.2µF, 1206 10µF, 1210 47µF	10V : 0201 47nF, 0402 1210 47µF	6.3V; 4V; Size 1812	
Size	Dielectric	Rated	Capacitance																																																																																																									
0201	X7R	10V	C 0.1µF																																																																																																									
		16V	C>0.1µF																																																																																																									
0402	X7R	6.3V, 10V, 16V, 25V	C 1.0µF																																																																																																									
0603	X7R	4V	C 22µF																																																																																																									
		6.3V,10V	C 4.7µF																																																																																																									
0805	X7R	25V, 35V	C 1.0µF																																																																																																									
		4V	C 47µF																																																																																																									
1206	X7R	6.3V, 10V	C 10µF																																																																																																									
		16V	C 47µF																																																																																																									
1210	X7R	16V	C 47µF																																																																																																									
		10V	C 3.3µF																																																																																																									
Size	Dielectric	Rated Voltage	Capacitance																																																																																																									
0201	X7R	10V	C 0.022µF																																																																																																									
0402	X7R	10V	C 0.1µF																																																																																																									
		5V	C 0.22µF																																																																																																									
0603	X7R	10V	C 0.082µF																																																																																																									
		6V, 50V	C 1.0µF																																																																																																									
0805	X7R	10V	C 4.7µF																																																																																																									
		10V	C 0.47µF																																																																																																									
1206	X7R	10V	C 0.12µF																																																																																																									
		10V	C 1.0µF																																																																																																									
1210	X7R	10V	C 1.0µF																																																																																																									
		10V	C 0.22µF																																																																																																									
1812	X7R	10V	C 4.7µF																																																																																																									
1825	X7R	100V	C 1.0µF																																																																																																									
2220																																																																																																												
2225																																																																																																												
Size	Dielectric	Rated Voltage	Capacitance																																																																																																									
2220	X7R	100V	C 15µF																																																																																																									
Rated voltage	I.R.																																																																																																											
100V : All X7R; 1210 3.3µF	1G or RxC 10 -F, whichever is smaller																																																																																																											
50V : 0402>0.01µF, 0603 1µF, 0805 1µF, 1206 4.7µF, 1210 4.7µF																																																																																																												
35V : 0603 1µF, 0805 2.2µF, 1206 2.2µF, 1210 10µF																																																																																																												
25V : 0603 1µF, 0805 2.2µF, 0805 2.2µF, 1206 10µF, 1210 10µF																																																																																																												
16V : 0201 0.1µF, 0603 1µF, 0805 2.2µF, 1206 10µF, 1210 47µF																																																																																																												
10V : 0201 47nF, 0402 1210 47µF																																																																																																												
6.3V; 4V; Size 1812																																																																																																												

8. RELIABILITY TEST CONDITIONS AND REQUIREMENTS

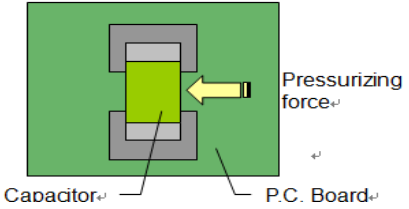
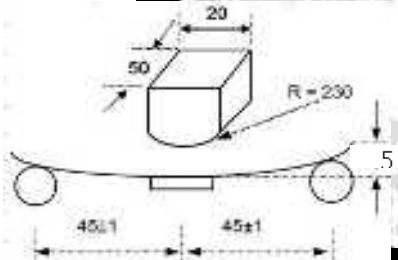
No.	Item	Test Condition	Requirements						
13.	Adhesive Strength of Termination	<p>* Capacitors mounted on a substrate. A force of 5N(0603) or 10N(>0603) applied perpendicular to the place of substrate and parallel the line joining the center of terminations for 10±1 second.</p>  <p>Capacitor, P.C. Board, Pressurizing force</p>	<p>* No remarkable damage or removal of the terminations.</p>						
14.	Bending Test	<p>* The middle part of the capacitor shall be pressurized by means of the pressurizing rod at a rate of about 1mm per second until the deflection becomes 5mm for product size < 1808mm for product size ≥ 1808.</p>  <p>Unit : mm</p>	<p>* No remarkable damage</p> <table border="1"> <thead> <tr> <th>Dielectric</th> <th>Cap. Change</th> </tr> </thead> <tbody> <tr> <td>Class I (C0G)</td> <td>Within ±5.0% or ±0.5pF, whichever is larger</td> </tr> <tr> <td>Class II (X7R)</td> <td>Within ±12.5%</td> </tr> </tbody> </table> <p>(This capacitance change means the change of capacitance under specified flexure of the capacitor from the capacitance measured before the test)</p>	Dielectric	Cap. Change	Class I (C0G)	Within ±5.0% or ±0.5pF, whichever is larger	Class II (X7R)	Within ±12.5%
Dielectric	Cap. Change								
Class I (C0G)	Within ±5.0% or ±0.5pF, whichever is larger								
Class II (X7R)	Within ±12.5%								
15.	Vibration Resistance	<p>* Vibration frequency : 10~55 Hz/min. * Total amplitude : 1.5mm. * Test time : 6 hrs. (Two hrs each in three mutually perpendicular directions) * Before initial measurement (Class II only) : To apply de-aging at 150°C for 1hr then set for 24±2 hrs at room temp. * Measurement to be made after keeping at room temp. for 24±2 hrs (Class I) or 48±4 hrs (Class II).</p>	<p>* No remarkable damage. * Cap. change and D.F./Q : To meet initial spec.</p>						

9. PACKAGE DIMENSION AND QUANTITY

Size	Thickness (mm)	Paper tape		Plastic tape	
		7" reel	13" reel	7" reel	13" reel
0402(1005)	0.50±0.05	10k	50k	-	-
	0.50 +0.02/-0.05	10k	50k	-	-
	0.50±0.20	10k	-	-	-
0603(1608)	0.50±0.10	4k	-	-	-
	0.80±0.07	4k	15k	-	-
	0.80 +0.15/-0.10	4k	15k	-	-
0805(2012)	0.50±0.10	4k	15k	-	-
	0.60±0.10	4k	15k	-	-
	0.80±0.10	4k	15k	-	-
	0.85±0.10	4k	15k	-	-
	1.25±0.10	-	-	3k	10k
1206(3216)	1.25±0.20	-	-	3k	10k
	0.80±0.10	4k	15k	-	-
	0.85±0.10	4k	15k	-	-
	0.95±0.10	-	-	3k	10k
	1.15±0.10	-	-	3k	10k
	1.25±0.10	-	-	3k	10k
	1.60±0.20	-	-	2k	10k
1210(3225)	1.60 +0.30/-0.10	-	-	2k	9k
	0.85±0.10	-	-	3k	10k
	0.95±0.10	-	-	3k	10k
	1.25±0.10	-	-	3k	10k
	1.60±0.20	-	-	2k	-
1808(4520)	2.00±0.20	-	-	1k	6k
	2.50±0.30	-	-	1k	6k
	1.25±0.10	-	-	2k	10k
	1.60±0.20	-	-	2k	8k
1812(4532)	2.00±0.20	-	-	1k	6k
	1.25±0.10	-	-	1k	5k
	1.60±0.20	-	-	1k	-
	2.00±0.20	-	-	1k	-
1825(4563)	2.50±0.30	-	-	0.5k	3k
	2.80±0.30	-	-	0.5k	-
	1.60±0.20	-	-	1k	-
	2.00±0.20	-	-	1k	-
2220(5750)	2.50±0.30	-	-	0.5k	-
	2.80±0.30	-	-	0.5k	-
	1.60±0.20	-	-	1k	-
2225(5763)	2.00±0.20	-	-	1k	-
	2.50±0.30	-	-	0.5k	-
	2.80±0.30	-	-	0.5k	-
	1.60±0.20	-	-	1k	-

Unit : pcs

9. PACKAGE DIMENSION AND QUANTITY

9.1. EMBOSSED TAPE DIMENSIONS

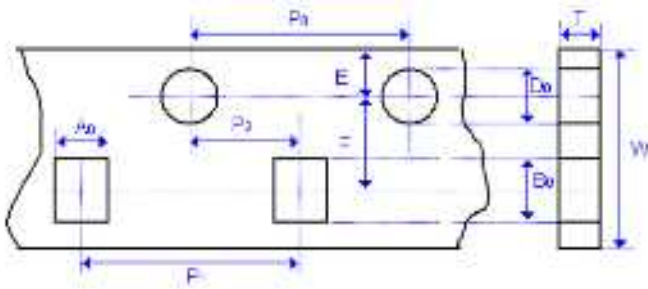

Fig. 9.1 The dimension of paper tape

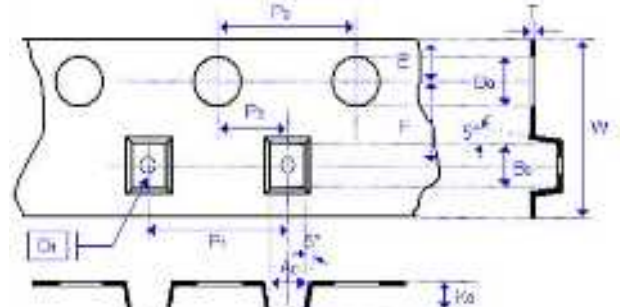

Fig. 9.2 The dimension of plastic tape

Size	0402		0603		0805	
Chip Thickness	0.50±0.05	0.50±0.10	0.80±0.07	0.80±0.15/0.1	0.80±0.10	1.25±0.10 1.25±0.20
A ₀	0.70±0.20	0.70±0.20	1.00 +0.05/-0.1	1.00±0.1	1.50±0.10	<1.65
B ₀	1.20±0.20	1.20±0.20	1.80±0.10	1.80±0.10	2.30±0.10	<2.40
T	0.80	0.80	0.95±0.05	0.97±0.05	0.95±0.05	0.23±0.05
K ₀	-	-	-	-	-	<2.50
W	8.00±0.10	8.00±0.10	8.00±0.10	8.00±0.10	8.00±0.10	8.00±0.10
P ₀	4.00±0.10	4.00±0.10	4.00±0.10	4.00±0.10	4.00±0.10	4.00±0.10
10xP ₀	40.00±0.10	40.00±0.10	40.00±0.20	40.00±0.20	40.00±0.20	40.00±0.20
P ₁	2.00±0.05	2.00±0.05	4.00±0.10	4.00±0.10	4.00±0.10	4.00±0.10
P ₂	2.00±0.05	2.00±0.05	2.00±0.05	2.00±0.05	2.00±0.05	2.00±0.05
D ₀	1.55±0.05	1.55±0.05	1.55±0.05	1.55±0.05	1.55±0.05	1.50 +0.10/-0
D ₁	-	-	-	-	-	1.00±0.10
E	1.75±0.05	1.75±0.05	1.75±0.05	1.75±0.05	1.75±0.05	1.75±0.10
F	3.50±0.05	3.50±0.05	3.50±0.05	3.50±0.05	3.50±0.05	3.50±0.05
Unit :	mm		mm		mm	

Size	1206			1210		1808		
Chip Thickness	0.80±0.10	0.95±0.10 1.25±0.10	1.25±0.10 1.60±0.20	1.25±0.10 1.60±0.20	2.50±0.30	1.25±0.10 1.60±0.20	2.00±0.20	
A ₀	2.00±0.10	<2.00	<2.50	<2.50	<3.10	<2.50	<2.50	
B ₀	3.50±0.10	<3.60	<5.30	<5.30	<4.00	<5.30	<5.30	
T	0.95±0.05	0.23±0.05	0.25±0.05	0.25±0.05	0.23±0.05	0.25±0.05	0.25±0.05	
K ₀	-	<2.50	<2.50	<2.50	<3.50	<2.50	<2.50	
W	8.00±0.10	8.00±0.10	12.00±0.20	12.00±0.20	12.00±0.20	12.00±0.20	12.00±0.20	
P ₀	4.00±0.10	4.00±0.10	4.00±0.10	4.00±0.10	4.00±0.10	4.00±0.10	4.00±0.10	
10xP ₀	40.00±0.20	40.00±0.20	40.0±0.20	40.0±0.20	40.00±0.20	40.0±0.20	40.0±0.20	
P ₁	4.00±0.10	4.00±0.10	4.00±0.10	4.00±0.10	4.00±0.10	4.00±0.10	4.00±0.10	
P ₂	2.00±0.05	2.00±0.05	2.00±0.05	2.00±0.05	2.00±0.05	2.00±0.05	2.00±0.05	
D ₀	1.55±0.05	1.50 +0.10/-0	1.50±0.10/-0	1.50±0.10/-0	1.50 +0.10/-0	1.50±0.10/-0	1.50+0.10/-0	
D ₁	-	1.00±0.10	1.50±0.10	1.50±0.10	1.00±0.10	1.50±0.10	1.50±0.10	
E	1.75±0.10	1.75±0.10	1.75±0.10	1.75±0.10	1.75±0.10	1.75±0.10	1.75±0.10	
F	3.50±0.05	3.50±0.05	5.50±0.05	5.50±0.05	3.50±0.05	5.50±0.05	5.50±0.05	
Unit :	mm		mm		mm		mm	

9. PACKAGE DIMENSION AND QUANTITY

Size	1812		1825		2220	
Chip Thickness	1.25±0.10 1.60±0.20 2.00±0.20	2.50±0.30	1.60±0.20 2.00±0.20	2.50±0.30	1.40±0.15 1.60±0.20 2.00±0.20	2.50±0.30
A ₀	<3.90	<3.90	<6.80	<6.80	<5.80	<6.80
B ₀	<5.30	<5.30	<5.30	<5.30	<6.50	<6.50
T	0.25±0.05	0.25±0.05	0.30±0.10	0.30±0.10	0.30±0.10	0.30±0.10
K ₀	<2.50	<3.00	<2.50	<3.10	<2.50	<3.10
W	12.00±0.20	12.00±0.20	12.00±0.20	12.00±0.20	12.00±0.20	12.00±0.20
P ₀	4.00±0.10	4.00±0.10	4.00±0.10	4.00±0.10	4.00±0.10	4.00±0.10
10xP ₀	40.00±0.20	40.00±0.20	40.00±0.20	40.00±0.20	40.00±0.20	40.00±0.20
P ₁	8.00±0.10	8.00±0.10	8.00±0.10	8.00±0.10	8.00±0.10	8.00±0.10
P ₂	2.00±0.05	2.00±0.05	2.00±0.05	2.00±0.05	2.00±0.05	2.00±0.05
D ₀	1.50 +0.10/-0	1.50 +0.10/-0	1.50 +0.10/-0	1.50 +0.10/-0	1.50 +0.10/-0	1.50 +0.10/-0
D ₁	1.50±0.10	1.50±0.10	1.50±0.10	1.50±0.10	1.50±0.10	1.50±0.10
E	1.75±0.10	1.75±0.10	1.75±0.10	1.75±0.10	1.75±0.10	1.75±0.10
F	5.50±0.05	5.50±0.05	5.50±0.05	5.50±0.05	5.50±0.05	5.50±0.05
Unit :	mm	mm	mm	mm	mm	mm

Size	2220	
Chip Thickness	1.60±0.20 2.00±0.20	2.50±0.30
A ₀	<6.80	<6.80
B ₀	<6.50	<6.50
T	0.30±0.10	0.30±0.10
K ₀	<2.50	<3.10
W	12.00±0.20	12.00±0.20
P ₀	4.00±0.10	4.00±0.10
10xP ₀	40.00±0.20	40.00±0.20
P ₁	8.00±0.10	8.00±0.10
P ₂	2.00±0.05	2.00±0.05
D ₀	1.50 +0.10/-0	1.50 +0.10/-0
D ₁	1.50±0.10	1.50±0.10
E	1.75±0.10	1.75±0.10
F	5.50±0.05	5.50±0.05
Unit :	mm	mm

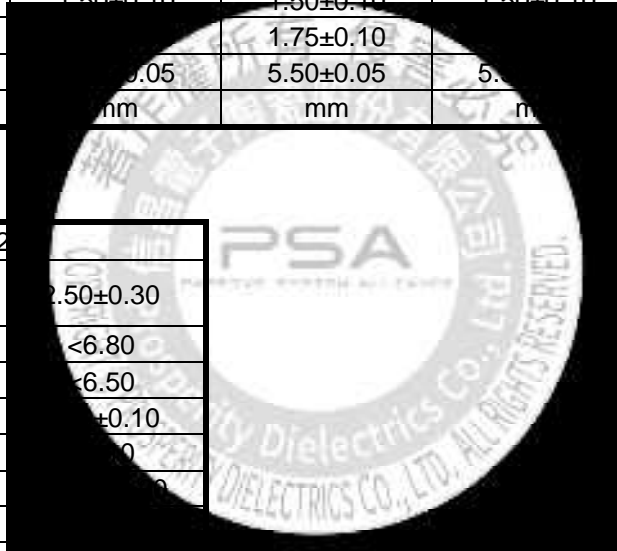

9. PACKAGE DIMENSION AND QUANTITY

9.2. REEL DIMENSIONS

Size	0402, 0603, 0805, 1206, 1210		1808, 1812, 1825, 2220, 2225
Reel size	7"	13"	7"
C	13.0 +0.5/-0.2	13.0 +0.7/-0.3	13.0 +0.5/-0.2
W ₁	8.4 +1.5/-0	8.4 +2.0/-0	12.4 +2.0/-0
A	178.0 ±0.10	330.0 ±1.0	178.0 ±0.10
N	60.0 +1.0/-0	±	60.0 +1.0/-0

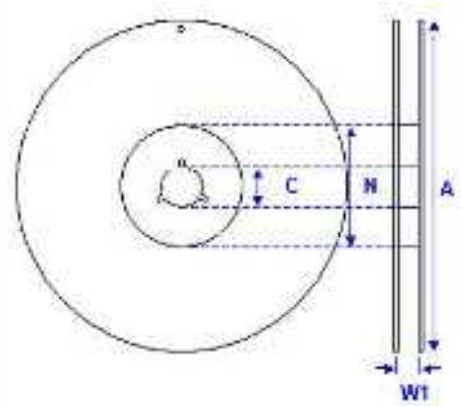

Fig. 1 Dimension of reel



10. APPLICATION NOTES

STORAGE

To prevent the damage of solderability of terminations, the following storage conditions are recommended :
Indoors under 5 ~ 40°C and 20% ~ 70% RH.

No harmful gases containing sulfuric acid, ammonia, hydrogen sulfide or chlorine.

Packaging should not be opened until the capacitors are required for use. If opened, the pack should be re-sealed as soon as is practicable. Taped product should be stored out of direct sunlight, which might promote deterioration in tape or adhesion performance. The product is recommended to be used within 12 months after shipment and checked the solderability before use.

HANDLING

Chip capacitors are dense, hard, brittle, and abrasive materials. They are liable to suffer mechanical damage, in the form of cracks or chips. Chip Capacitors should be handled with care to avoid contamination or damage. To use vacuum or plastic tweezers to pick up or plastic tweezers is recommended for manual placement. Tape and reeled packages are suitable for automatic pick and placement machine.

PREHEAT

In order to minimize the thermal shock during soldering, a carefully controlled preheat is required. The rate of preheat should not exceed 3°C per second.

SOLDERING

Use rosin activated fluxes (RA and RMA fluxes) do not use activated fluxes. The amount of solder in each solder joint should be controlled to prevent the damage of chip capacitors caused by the stress between solder, chips, and substrate.

a.) Hand soldering :

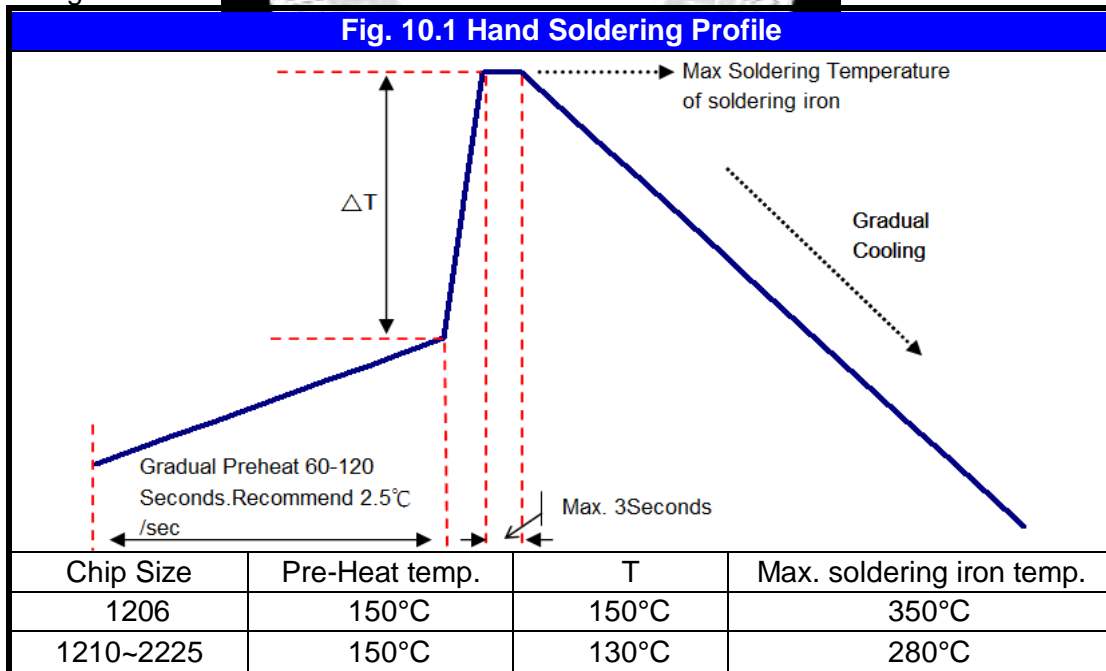
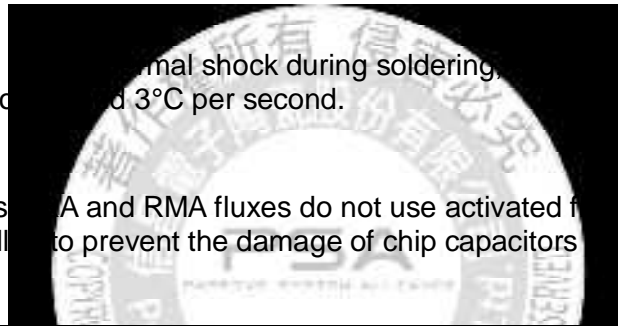

* Soldering iron tip diameter 1.0 mm and wattage max. 20W.

* The Capacitors shall be pre-heated and that the temperature gradient between the devices and the tip of the soldering iron.

* The required amount of solder shall be melted on the soldering tip.

* The tip of iron should not contact the ceramic body directly.

* The Capacitors shall be cooled gradually at room temperature after soldering.

* Forced air cooling is not allowed.

10. APPLICATION NOTES

b.) Reflow soldering :

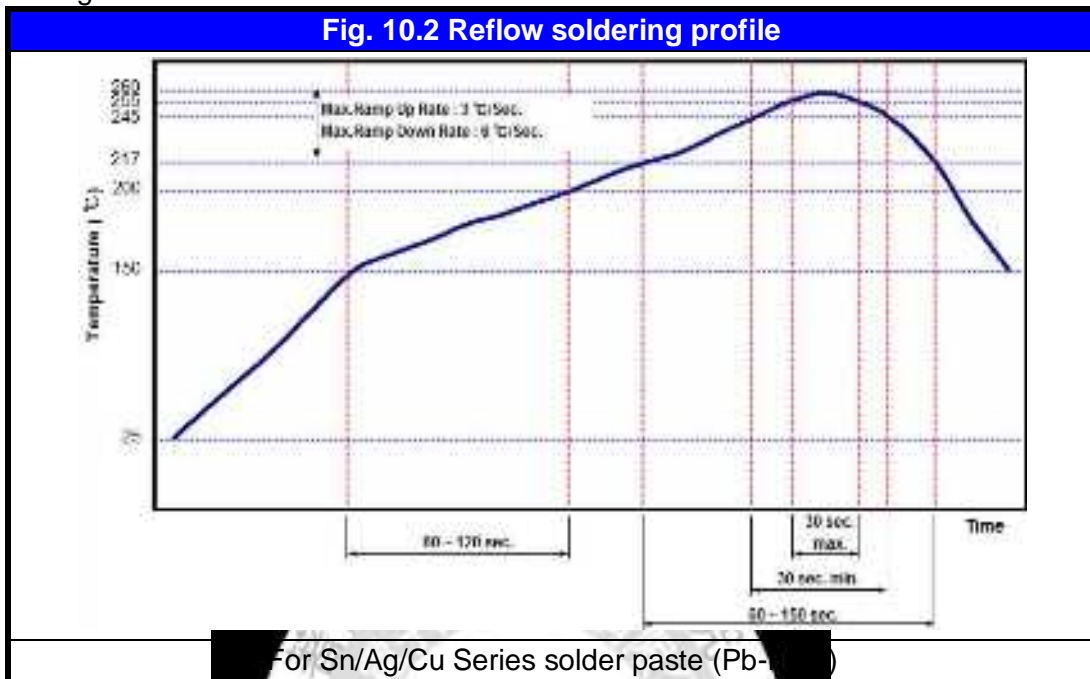

c.) Wave soldering :

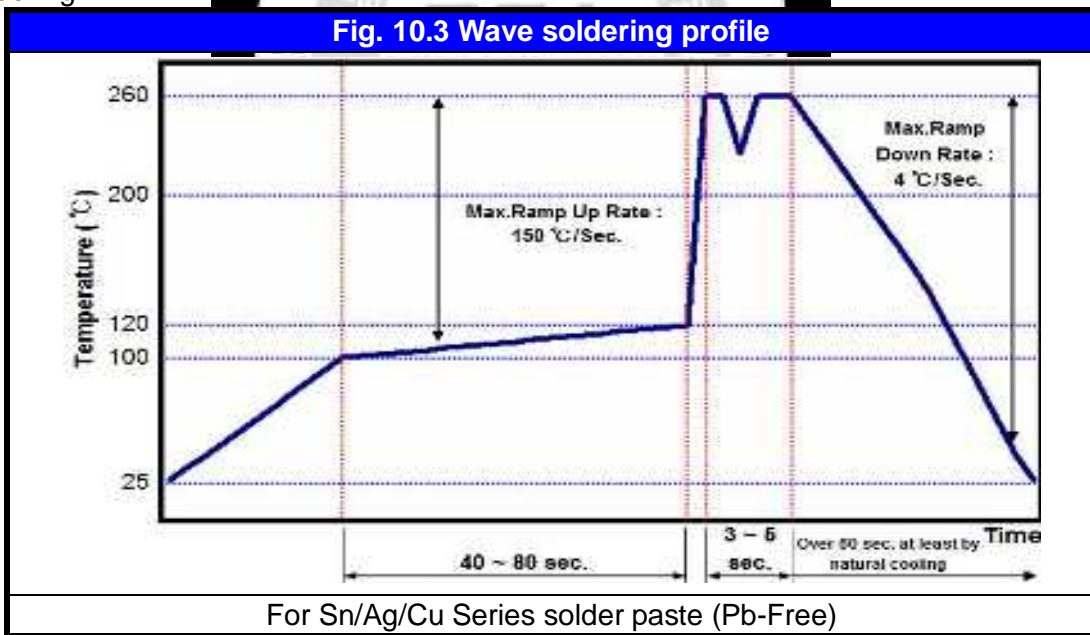

Soldering conditions :

Class I :

Size Inch (mm)	Temper. Cher.	Capacitance	Condition	
			Wave	Reflow
0402 (1005)	All Class I	All	X	
0603 (1608)	All Class I	All	Not recommended	
0805 (2012)	All Class I	All	Not recommended	
1206 (3216)	All Class I	All	Not recommended	
1210 (3225)	All Class I	All	X	

10. APPLICATION NOTES

Soldering conditions :
Class II :

Size Inch (mm)	Temper. Cher.	Capacitance	Condition	
			Wave	Reflow
0402 (1005)	All Class II	All	X	
0603 (1608)	All Class II	Cap. <2.2 μ F	Not recommended	
		Cap. 2.2 μ F	X	
0805 (2012)	All Class II	Cap. <4.7 μ F	Not recommended	
		Cap. 4.7 μ F	X	
1206 (3216)	All Class II	Cap. <4.7 μ F	Not recommended	
		Cap. 4.7 μ F	X	
1210 (3225)	All Class II	All	X	

Soldering height :

The solder climbing minimum height is suggesting to 25% of chip thickness or 50 μ m whichever is less.
(Reference from IPC-610E)

The diagram illustrates a cross-section of a chip on a substrate. A vertical double-headed arrow on the left indicates the 'Chip Thickness'. A horizontal double-headed arrow on the right indicates the 'Soldering Height', which is the distance from the substrate surface to the top of the solder bridge on the chip.

COOLING

After soldering, cool the substrate gradually to room temperature. Natural cooling in air is recommended to minimize stress on the solder joint.

CLEANING

All flux residues must be removed by using suitable electronic-grade vapor-cleaning solvents to eliminate contamination that could cause electrolytic surface corrosion. Good results can be obtained by using ultrasonic cleaning of the solvent. The choice of the proper system is depends upon many factors such as component mix, flux, and solder paste and assembly method. The ability of the cleaning system to remove flux residues and contamination from under the chips is very important.

11. Typical Bending Cracks of MLCC

MLCC ceramic body is consisted of rigidity material. It will be suffered compressive and tensional stress when the carried board is bended. If the suffered stress is over ceramic body strength, the bending crack is occurred. **Therefore, the bending crack will be only occurred after soldering process.**

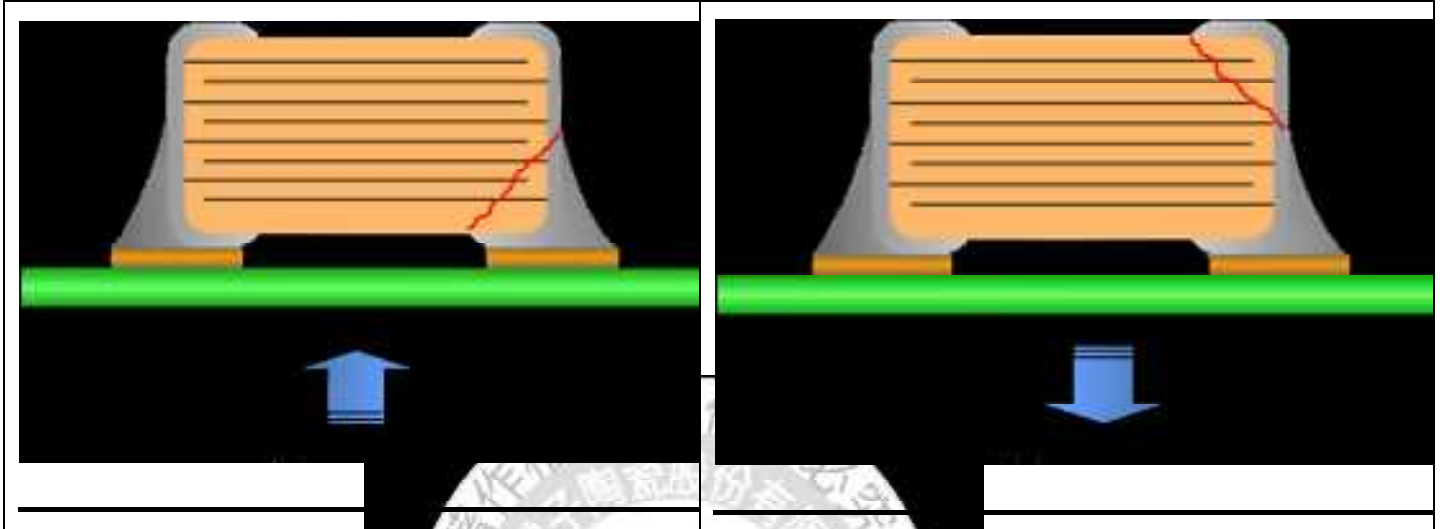

12. The stress v.s. position on PCB during bending

Chip mounting close to board separation point

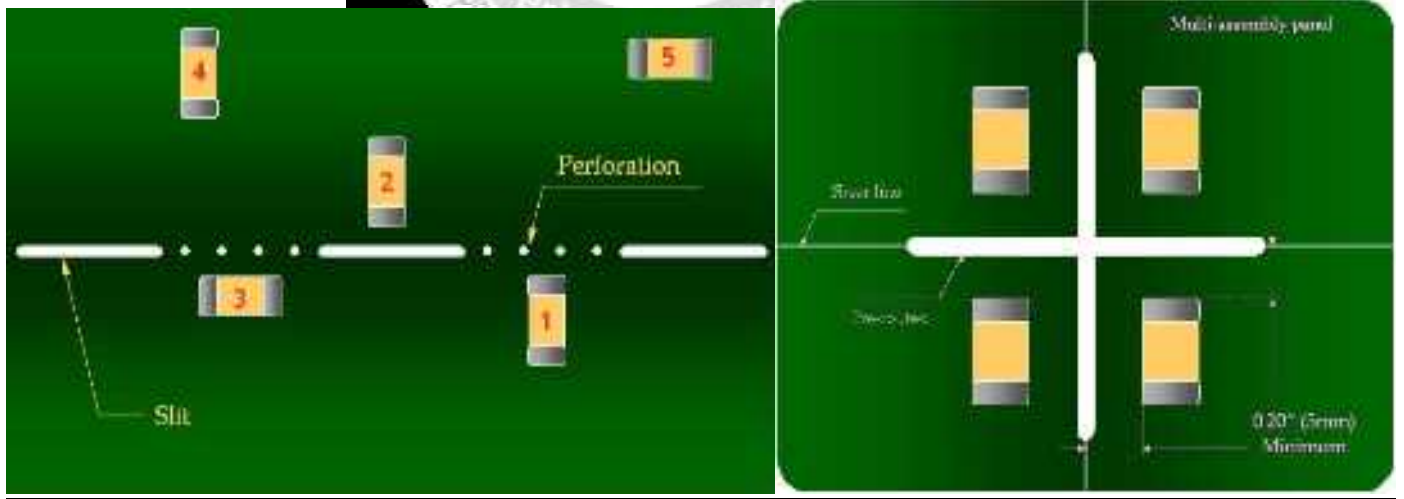

Magnitude of stress 1 > 2 3 > 4 > 5

13. Structure

PDC soft termination series is added a special termination material(Ultra-Buffer or Anti-Bend)between ceramic body and Ni-barrier that can absorb mechanical stress to prevent bending crack occurred

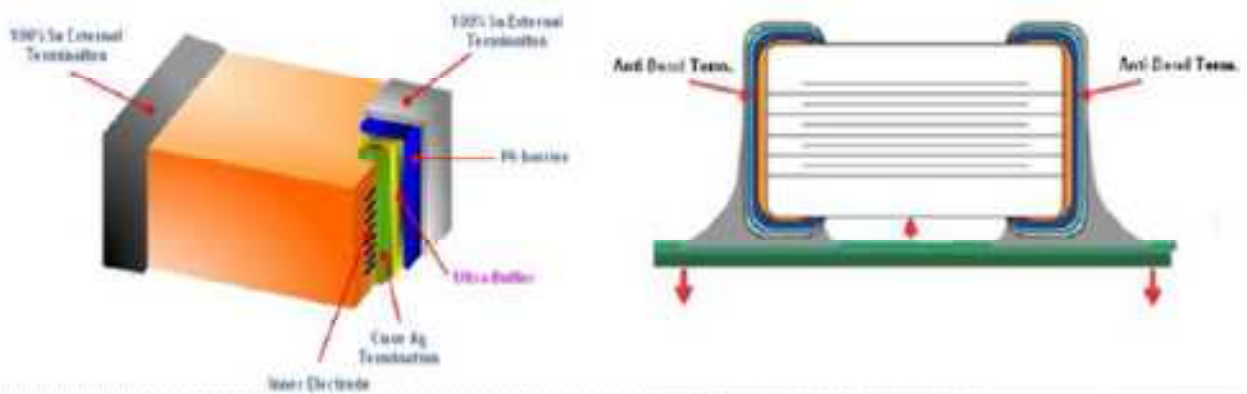

14. Illustration of Bending Test

